

STIHL[®]

STIHL HL 94

Instruction Manual



Contents

| | |
|---|----|
| Guide to Using this Manual | 2 |
| Safety Precautions and Working Techniques | 2 |
| Using the Unit | 8 |
| Approved Power Tool Attachments | 10 |
| Assembling the Unit | 10 |
| Fuel | 12 |
| Fueling | 13 |
| Adjusting the Cutter Bar | 13 |
| Fitting the Harness | 15 |
| Starting / Stopping the Engine | 16 |
| Operating Instructions | 18 |
| Cleaning the Air Filter | 18 |
| Adjusting the Carburetor | 19 |
| Spark Plug | 19 |
| Lubricating the Gearbox | 20 |
| Sharpening Instructions | 21 |
| Storing the Machine | 22 |
| Inspection and Maintenance by User | 22 |
| Inspections and Maintenance by Dealer | 22 |
| Maintenance and Care | 23 |
| Minimize Wear and Avoid Damage | 25 |
| Main Parts | 26 |
| Specifications | 27 |
| Maintenance and Repairs | 28 |
| Disposal | 28 |
| EC Declaration of Conformity | 29 |

Dear Customer,

Thank you for choosing a quality engineered STIHL product.

It has been built using modern production techniques and comprehensive quality assurance. Every effort has been made to ensure your satisfaction and trouble-free use of the product.

Please contact your dealer or our sales company if you have any queries concerning this product.

Your



Dr. Nikolas Stihl

STIHL®

HL 94, HL 94 K

This instruction manual is protected by copyright. All rights reserved, especially the rights to reproduce, translate and process with electronic systems.

Guide to Using this Manual

Pictograms

The meanings of the pictograms attached to the machine are explained in this manual.

Depending on the model concerned, the following pictograms may be attached to your machine.



Fuel tank; fuel mixture of gasoline and engine oil

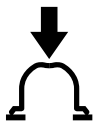

Operate manual fuel pump

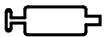

Filler hole for gear lubricant

Symbols in text



WARNING

Warning where there is a risk of an accident or personal injury or serious damage to property.



NOTICE

Caution where there is a risk of damaging the machine or its individual components.

Engineering improvements

STIHL's philosophy is to continually improve all of its products. For this reason we may modify the design, engineering and appearance of our products periodically.

Therefore, some changes, modifications and improvements may not be covered in this manual.

Safety Precautions and Working Techniques



Because a hedge trimmer is a high-speed, fast-cutting power tool with very sharp cutting blades and a long reach, special safety precautions must be observed during operation.



It is important that you read the instruction manual before first use and keep it in a safe place for future reference. Non-observance of the instruction manual may result in serious or even fatal injury.

Observe all applicable local safety regulations, standards and ordinances.

If you have not used this type of power tool before: Have your dealer or other experienced user show you how it is operated or attend a special course in its operation.

Minors should never be allowed to use a power tool.

Keep bystanders, especially children, and animals away from the work area.

When the power tool is not in use, shut it off so that it does not endanger others. Secure it against unauthorized use.

The user is responsible for avoiding injury to third parties or damage to their property.

Do not lend or rent your power tool without the instruction manual. Be sure that anyone using your power tool understands the information contained in this manual.

The use of noise emitting power tools may be restricted to certain times by national or local regulations.

To operate the power tool you must be rested, in good physical condition and mental health.

If you have any condition that might be aggravated by strenuous work, check with your doctor before operating a power tool.

Persons with pacemakers only: The ignition system of your power tool produces an electromagnetic field of a very low intensity. This field may interfere with some pacemakers. STIHL recommends that persons with pacemakers consult their physician and the pacemaker manufacturer to reduce any health risk.

Do not operate the power tool if you are under the influence of any substance (drugs, alcohol) which might impair vision, dexterity or judgment.

Use your hedge trimmer only for cutting hedges, shrubs, scrub and similar materials.

It must not be used for any other purpose because of the increased risk of accidents and damage to the machine. Never attempt to modify your power tool in any way since this may result in accidents or damage to the machine.

Only use cutting blades and accessories that are explicitly approved for this power tool by STIHL or are technically

identical. If you have any questions in this respect, consult a servicing dealer. Use only high quality tools and accessories in order to avoid the risk of accidents and damage to the machine.

STIHL recommends the use of genuine STIHL tools and accessories. They are specifically designed to match the product and meet your performance requirements.

Never attempt to modify your machine in any way since this may increase the risk of personal injury. STIHL excludes all liability for personal injury and damage to property caused while using unauthorized attachments.

Do not use a pressure washer to clean your power tool. The solid jet of water may damage parts of the power tool.

Do not spray the machine with water.

Clothing and Equipment

Wear proper protective clothing and equipment.



Clothing must be sturdy but allow complete freedom of movement. Wear snug-fitting clothing, an overall and jacket combination, do not wear a work coat.



Avoid clothing that could get caught on branches or brush or moving parts of the machine. Do not wear a scarf, necktie or jewelry. Tie up and confine long hair (e.g. with a hair net, cap, hard hat, etc.).



Wear steel-toed safety boots with non-slip soles.



WARNING



To reduce the risk of eye injuries, wear close-fitting safety glasses in accordance with European Standard EN 166. Make sure the safety glasses are a comfortable and snug fit.

Wear hearing protection, e.g. earplugs or ear muffs.

Wear a safety hard hat with chin strap where there is a danger of head injuries from falling objects.



Wear heavy-duty work gloves made of durable material (e.g. leather).

STIHL offers a comprehensive range of personal protective clothing and equipment.

Transporting the Power Tool

Always shut off the engine.

Always fit the blade guard (scabbard) before carrying your hedge trimmer short distances.

On units with a defined transport position: Move the cutter bar to the transport position and make sure it is properly engaged.

Carry the power tool properly balanced by the drive tube – cutting blades behind you.

To reduce the risk of serious burn injuries, avoid touching hot parts of the machine, including the gearbox housing.

Transporting by vehicle: Properly secure your power tool to prevent turnover, fuel spillage and damage.

Fueling



Gasoline is an extremely flammable fuel. Keep clear of naked flames. Do not spill any fuel – do not smoke.

Always **shut off the engine** before refueling.

Do not fuel a hot engine – fuel may spill and **cause a fire**.

Open the fuel cap carefully to allow any pressure build-up in the tank to release slowly and avoid fuel spillage.

Fuel your power tool only in well-ventilated areas. If you spill fuel, wipe the machine immediately – if fuel gets on your clothing, change immediately.



After fueling, tighten down the fuel tank cap as securely as possible.

This reduces the risk of unit vibrations causing the fuel cap to loosen or come off and spill quantities of fuel.

To reduce the risk of serious or fatal burn injuries, check for fuel leakage. If fuel leakage is found, do not start or run the engine until leak is fixed.

Before Starting

Check that your power tool is properly assembled and in good condition – refer to appropriate chapters in the instruction manual.

- Check the fuel system for leaks, paying special attention to visible parts such as the tank cap, hose connections and the manual fuel pump (on machines so equipped). If there are any leaks or damage, do not start the engine – **risk of fire**. Have your machine repaired by a servicing dealer before using it again.
- The stop switch must move freely.
- Smooth action of choke knob, throttle trigger lockout and throttle trigger – the throttle trigger must return automatically to the idle position. The choke knob must spring back from the **II** position to the run position **I** when the throttle trigger lockout and throttle trigger are squeezed.

- Check that the spark plug boot is secure – a loose boot may cause arcing that could ignite combustible fumes **and cause a fire**.
- Cutting blades securely mounted and in good condition (clean, move freely, not warped), properly sharpened and thoroughly sprayed with STIHL resin solvent (lubricant).
- On units with adjustable cutter bar: Make sure the adjuster is properly engaged in the required position for starting.
- On units with a defined transport position (cutter bar folded against drive tube): Never attempt to start the unit in the transport position.
- Never attempt to modify the controls or safety devices in any way.
- Keep the handles dry and clean – free from oil and dirt – for safe control of the power tool.
- Adjust shoulder strap and handles to suit your height and reach. See chapter on "Fitting the Harness".

To reduce the risk of accidents, do not operate your power tool if it is damaged or not properly assembled.

If you use a shoulder strap: Practice removing and putting down the machine as you would in an emergency. To avoid damage, do not throw the machine to the ground when practicing.

Starting the Engine

Start the engine at least 3 meters from the fueling spot, outdoors only.

Place the power tool on firm ground in an open area. Make sure you have good balance and secure footing. Hold the power tool securely. The cutting blades must be clear of the ground and all other obstructions because they may begin to run when the engine starts.

Your power tool is designed to be operated by one person only. Do not allow other persons in the work area – even when starting.

To reduce the risk of injury, avoid contact with the cutting blades.

Do not drop start the power tool – start the engine as described in the instruction manual. Note that the cutting blades continue to run for a short period after you let go of the throttle trigger (flywheel effect).

Check idle speed setting: The cutting blades must not move when the engine is idling with the throttle trigger released.

To reduce the risk of fire, keep hot exhaust gases and hot muffler away from easily combustible materials (e.g. wood chips, bark, dry grass, fuel).

Holding and Controlling the Power Tool

Always hold the power tool firmly with both hands on the handles.

Make sure you have firm and secure footing and hold the power tool so that the cutting blades are always away from your body.

Some versions of the machine can be carried on a harness to relieve the weight on the operator's arms.

Models with loop handle

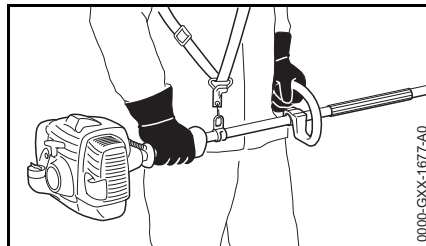

Right hand on control handle, left hand on loop handle on drive tube, even if you are left-handed. Wrap fingers and thumbs firmly around the handles.

Machines with handle hose

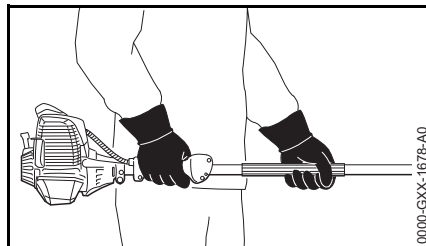

Right hand on control handle, left hand on handle hose on drive tube, even if you are left-handed. Wrap fingers and thumbs firmly around the handles.

During Operation

In the event of impending danger or in an emergency, switch off the engine immediately – move the stop switch in the direction of 0.



This power tool is not insulated against electric shock. **To reduce the risk of electrocution**, keep well clear of electric power lines.

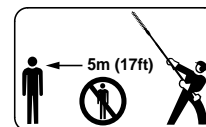

To reduce the risk of injury from moving blades or falling cuttings, do not allow bystanders within 5 meters of your own position.

To reduce the risk of damage to property, also maintain this distance from other objects (vehicles, windows).

Watch the cutting blades at all times – do not cut areas of the hedge that you cannot see.

Be extremely careful when cutting tall hedges, check the other side of the hedge before starting work.

Make sure the idle speed setting is correct. The cutting blades must not run when the engine is idling with the throttle trigger released. Check and correct the idle speed setting regularly. If the cutting blades still run when the engine is idling, have your dealer check your machine and make proper adjustments or repairs.

Note that the cutting blades continue to run for a short period after you let go of the throttle trigger – **flywheel effect**.

Take special care in slippery conditions (ice, wet ground, snow) – on slopes or uneven ground.

Clear away fallen branches, scrub and cuttings.

Watch out for obstacles: Roots and tree stumps which **could cause you to trip or stumble**.

Make sure you always have good balance and secure footing.

When working at heights:

- Always use a lift bucket
- Never work on a ladder or in a tree
- Never work on an insecure support
- Never operate your power tool with one hand

Be particularly alert and cautious when wearing hearing protection because your ability to hear warnings (shouts, alarms, etc.) is restricted.

To reduce the risk of accidents, take a break in good time to avoid tiredness or exhaustion.

Work calmly and carefully – in daylight conditions and only when visibility is good. Stay alert so as not to endanger others.



Your power tool produces toxic exhaust fumes as soon as the engine is running. These fumes may be colorless and odorless and contain unburned hydrocarbons and benzol. Never run the engine indoors or in poorly ventilated locations, even if your model is equipped with a catalytic converter.

To reduce the risk of serious or fatal injury from breathing toxic fumes, ensure proper ventilation when working in trenches, hollows or other confined locations.

To reduce the risk of accidents, stop work immediately in the event of nausea, headache, visual disturbances (e.g. reduced field of vision), problems with hearing, dizziness, deterioration in ability to concentrate. Apart from other possibilities, these symptoms may be caused by an excessively high concentration of exhaust gases in the work area.

Operate your power tool so that it produces a minimum of noise and emissions – do not run the engine unnecessarily, accelerate the engine only when working.

To reduce the risk of fire, **do not smoke** while operating or standing near your power tool. Note that combustible fuel vapor may escape from the fuel system.

The dusts, vapor and smoke produced during operation may be dangerous to health. If the work area is very dusty or smoky, wear a respirator.



The gearbox becomes hot during operation. **To reduce the risk of burn injury**, do not touch the gearbox housing.

If your power tool is subjected to unusually high loads for which it was not designed (e.g. heavy impact or a fall), always check that it is in good condition before continuing work – see also "Before Starting". Check the fuel system in particular for leaks and make sure the safety devices are working properly. Do

not continue operating your power tool if it is damaged. In case of doubt, consult your servicing dealer.

Do not operate your power tool in the starting throttle position – engine speed cannot be controlled in this position.

Inspect the hedge and work area to avoid damaging the cutting blades:

- Remove stones, rocks, pieces of metal and other solid objects.
- When working close to the ground, make sure that no sand, grit or stones get between the blades.
- Take particular care when cutting hedges next to or against wire fences.

To avoid the risk of electrocution, do not touch electric power lines – never cut through electric power lines.



Do not touch the cutting blades while the engine is running. If the cutting blades become jammed by an object, switch off the engine immediately before attempting to remove the object – **there is otherwise a risk of injury**.

Opening the throttle while the blades are blocked increases the load and reduces engine speed. The clutch then slips continuously and this causes overheating and damage to important components (e.g. clutch, polymer housing components) – and **this can increase the risk of injury** from the blades moving while the engine is idling.

If the hedge is very dusty or dirty, spray the blades with STIHL resin solvent from time to time during cutting. This helps greatly reduce blade friction as well as the aggressive effects of sap and the build-up of dirt particles.

Before leaving the power tool unattended: Shut off the engine.

Check the cutting blades at regular short intervals during operation or immediately if there is a noticeable change in cutting behavior:

- Shut off the engine.
- Wait until the cutting blades have come to a complete standstill.
- Check condition and tightness, look for cracks.
- Check sharpness.

To reduce the risk of fire, always clean plant residue, chips, leaves and excess lubricant off the engine and muffler.

After finishing work

Always clean dust and dirt off the machine – do not use any grease solvents for this purpose.

Spray the blades with STIHL resin solvent. Run the motor briefly to ensure that the solvent is evenly distributed.

Vibrations

Prolonged use of the power tool may result in vibration-induced circulation problems in the hands (whitefinger disease).

No general recommendation can be given for the length of usage because it depends on several factors.

The period of usage is prolonged by:

- Hand protection (wearing warm gloves)
- Work breaks

The period of usage is shortened by:

- Any personal tendency to suffer from poor circulation (symptoms: frequently cold fingers, tingling sensations).
- Low outside temperatures.
- The force with which the handles are held (a tight grip restricts circulation).

Continual and regular users should monitor closely the condition of their hands and fingers. If any of the above symptoms appear (e.g. tingling sensation in fingers), seek medical advice.

Maintenance and Repairs

Service the machine regularly. Do not attempt any maintenance or repair work not described in the instruction manual. Have all other work performed by a servicing dealer.

STIHL recommends that you have servicing and repair work carried out exclusively by an authorized STIHL servicing dealer. STIHL dealers are regularly given the opportunity to attend training courses and are supplied with the necessary technical information.

Only use high-quality replacement parts in order to avoid the risk of accidents and damage to the power tool. If you have any questions in this respect, consult a servicing dealer.

STIHL recommends the use of original STIHL replacement parts. They are specifically designed to match your model and meet your performance requirements.

To reduce the risk of injury, **always shut off the engine** before carrying out any maintenance or repairs or cleaning the machine. – Exception: Carburetor and idle speed adjustments.

Do not turn the engine over on the starter with the spark plug boot or spark plug removed since there is otherwise a **risk of fire** from uncontained sparking.

To reduce the **risk of fire**, do not service or store your machine near open flames.

Check the fuel filler cap for leaks at regular intervals.

Use only a spark plug of the type approved by STIHL and make sure it is in good condition – see "Specifications".

Inspect the ignition lead (insulation in good condition, secure connection).

Check the condition of the muffler.

To reduce the risk of fire and damage to hearing, do not operate your machine if the muffler is damaged or missing.

Do not touch a hot muffler since **burn injury** will result.

Vibration behavior is influenced by the condition of the AV elements – check the AV elements at regular intervals.

Using the Unit

Cutting Season

Observe country-specific or municipal rules and regulations for cutting hedges.

Do not use your hedge trimmer during rest periods customary in the neighborhood.

Cutting Sequence

If a radical cut is necessary, cut a little at a time in several stages.

Use lopping shears to cut out thick branches first.

Cut the sides of the hedge first, then the top.

Disposal

Do not throw cuttings into the garbage can – they can be composted.

Preparations

- Model with adjustable cutter bar: Set the cutter bar to the straight (0°) position.
- Remove the blade scabbard.
- Start the engine.
- If you use a harness: Put on the harness and attach it to the machine.

Working Techniques

Horizontal Cut (with cutter bar at an angle)



Cutting close to the ground from a standing position, e.g. low shrubs.

Swing the cutter bar from side to side as you move along – use both sides of the cutting blades, do not rest the cutter bar on the ground.



WARNING

K versions (HL 92 K, HL 94 K) are not approved for cutting close to the ground.

Vertical Cut (with cutter bar at an angle)



Cutting without standing directly next to the hedge, e.g. flowerbed between operator and hedge.

Swing the cutter bar up and down in an arc as you move along the hedge – use both sides of the cutting blades.

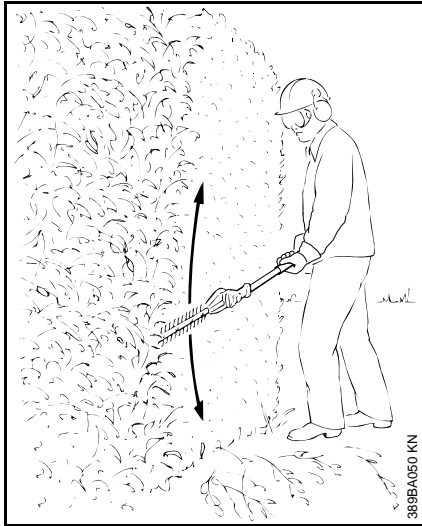
Vertical Cut (with straight cutter bar)

Extra long reach without the need for other aids.

Swing the cutter bar up and down in an arc as you move along the hedge – use both sides of the cutting blades.

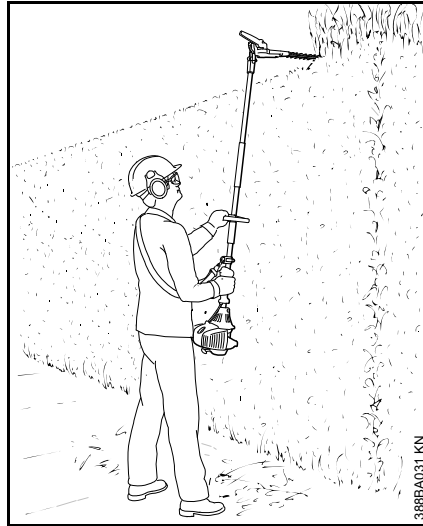
Overhead Cut (with cutter bar at an angle)

Hold the hedge trimmer vertically and swing it in an arc to make maximum use of its reach.

! WARNING

Any working position above head height is tiring. To minimize the risk of accidents, work in such positions for short periods only. Set the adjustable cutter bar to the most suitable angle so that the trimmer can be held in a lower, less tiring position while still providing adequate reach.

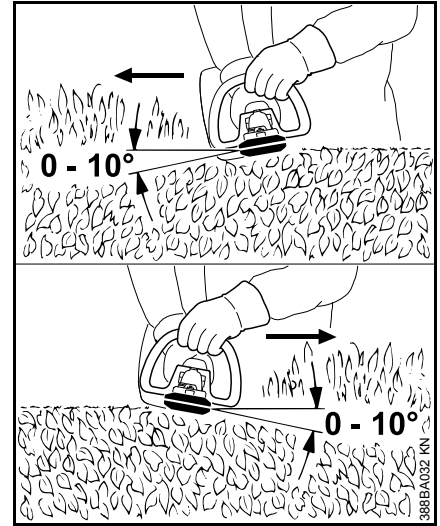
Horizontal Cut (with straight cutter bar)

Hold the cutter bar at an angle of 0° to 10° as you swing the hedge trimmer horizontally.

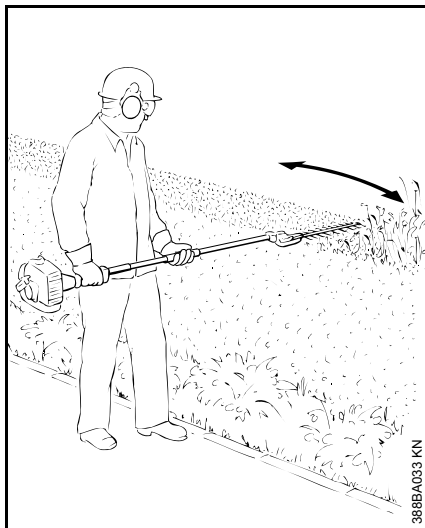

Swing the cutter bar in an arc towards the outside of the hedge so that the cuttings are swept to the ground.

Recommendation: Only cut hedges that are no more than chest high.

Approved Power Tool Attachments

The following STIHL attachments may be used with the basic power tool:

| Attachment | Application |
|-------------------------------|----------------------------|
| HL 0°, 500 mm ¹⁾ | Long reach hedge trimmer |
| HL 0°, 600 mm ¹⁾ | Long reach hedge trimmer |
| HL 145°, 500 mm ¹⁾ | Long reach hedge trimmer |
| HL 145°, 600 mm ¹⁾ | Long reach hedge trimmer |
| HT ²⁾ | Pole pruner |
| BF ^{2) 3)} | Cultivator with pick tines |
| SP 10 | Special harvester |

- 1) Loop handle required on versions with long drive tube (HL 92, HL 94)
- 2) Must not be mounted to versions with short drive tube (HL 92 K, HL 94 K)
- 3) Loop handle required

Assembling the Unit

Mounting the Loop Handle (HL 92, HL 94)

Loop handle is required on versions with long drive tube (HL 92, HL 94).

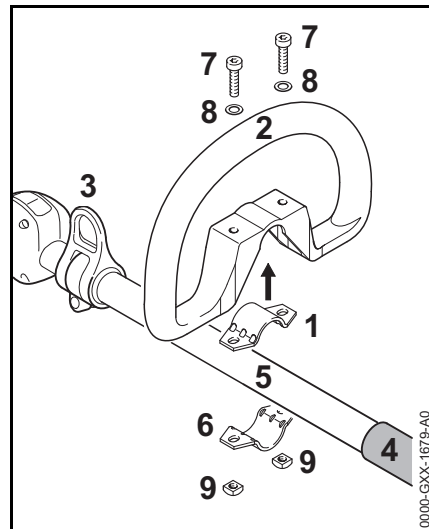

- Place the clamp (1) in the loop handle (2) and position them both against the drive tube (5) between the carrying ring (3) and handle hose (4).
- Position the clamp (6) against the shaft.
- Line up the holes.
- Insert the screws (7) with washers (8).
- Fit the square nuts (9) and screws.

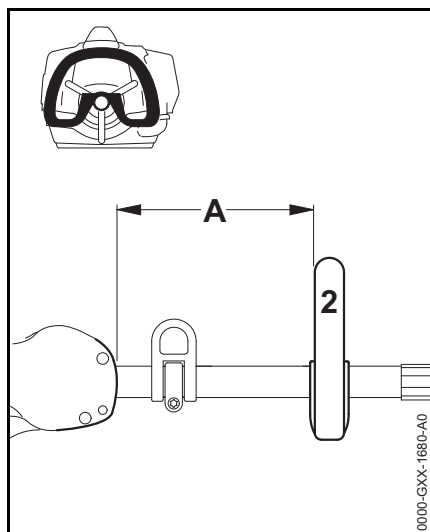

- Align the loop handle (2) and move it to the most comfortable position (recommended: about 20 cm).
- Tighten down the screws firmly.

Mounting the Gearbox

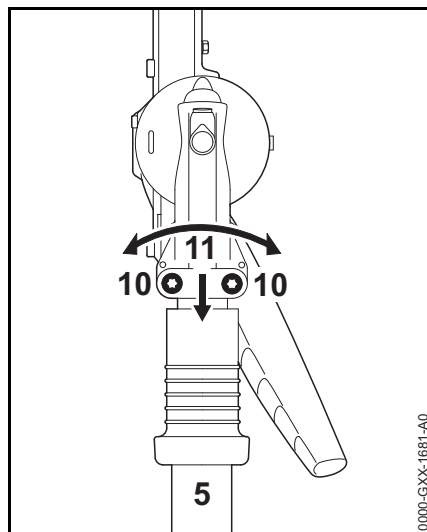

- Loosen the clamp screws (10).
- Push the gearbox (11) onto the drive tube (5), turn the gearbox (11) back and forth as necessary.

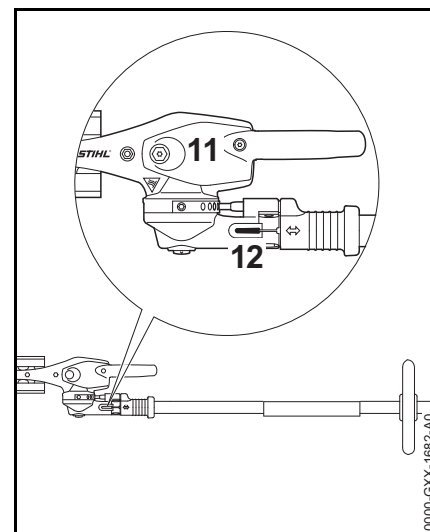

Once the end of the drive tube is inserted beyond the slot in the clamp (12):

- Push the gearbox (11) fully home as far as stop.
- Tighten down the clamp screws moderately.
- Line up the gearbox (11) with the powerhead.
- Tighten down the clamp screws firmly.

Fuel

Your engine requires a mixture of gasoline and engine oil.

WARNING

For health reasons, avoid direct skin contact with gasoline and avoid inhaling gasoline vapor.

STIHL MotoMix

STIHL recommends the use of STIHL MotoMix. This ready-to-use fuel mix contains no benzol or lead, has a high octane rating and ensures that you always use the right mix ratio.

STIHL MotoMix uses STIHL HP Ultra two-stroke engine oil for an extra long engine life.

MotoMix is not available in all markets.

Mixing Fuel

NOTICE

Unsuitable fuels or lubricants or mix ratios other than those specified may result in serious damage to the engine. Poor quality gasoline or engine oil may damage the engine, sealing rings, hoses and the fuel tank.

Gasoline

Use only high-quality **brand-name** gasoline with a minimum octane rating of 90 – leaded or unleaded.

Gasoline with an ethanol content of more than 10% can cause running problems in engines with a manually adjustable carburetor and should not be used in such engines.

Engines equipped with M-Tronic deliver full power when run on gasoline with an ethanol content of up to 25% (E25).

Engine Oil

If you mix the fuel yourself, use only STIHL two-stroke engine oil or another high-performance engine oil in accordance with JASO FB, JASO FC, JASO FD, ISO-L-EGB, ISO-L-EGC or ISO-L-EGD.

STIHL specifies STIHL HP Ultra two-stroke engine oil or an equivalent high-performance engine oil in order to maintain emission limits over the machine's service life.

Mix Ratio

STIHL 50:1 two-stroke engine oil: 50 parts gasoline to 1 part oil

Examples

| Gasoline Liters | STIHL engine oil 50:1 Liters | (ml) |
|--------------------|---------------------------------|-------|
| 1 | 0.02 | (20) |
| 5 | 0.10 | (100) |
| 10 | 0.20 | (200) |
| 15 | 0.30 | (300) |
| 20 | 0.40 | (400) |
| 25 | 0.50 | (500) |

- Use a canister approved for storing fuel. Pour oil into canister first, then add gasoline and mix thoroughly.

Storing Fuel

Store fuel only in approved safety-type fuel canisters in a dry, cool and safe location protected from light and the sun.

Fuel mix ages – only mix sufficient fuel for a few weeks work. Do not store fuel mix for longer than 30 days. Exposure to light, the sun, low or high temperatures can quickly make the fuel mix unusable.

STIHL MotoMix may be stored for up to 2 years without any problems.

- Thoroughly shake the mixture in the canister before fueling your machine.

WARNING

Pressure may build up in the canister – open it carefully.

- Clean the fuel tank and canister from time to time.

Dispose of remaining fuel and cleaning fluid properly in accordance with local regulations and environmental requirements.

Fueling

Fuel filler cap

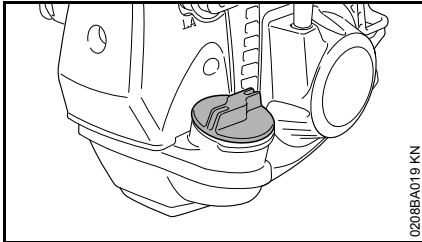

0208BA019 KN

! WARNING

When fueling on a slope, always position the machine with the filler cap facing uphill.

- Place the machine on level ground so that the filler cap is facing up.
- Before fueling, clean the filler cap and the area around it to ensure that no dirt falls into the tank.

Open the tank cap.

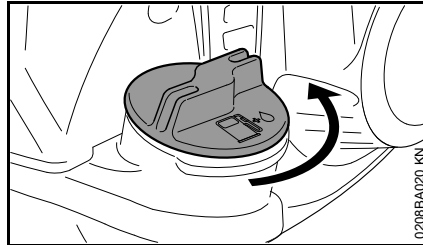

0208BA020 KN

- Turn the cap counterclockwise until it can be removed from the tank opening.
- Remove the cap.

Filling up with fuel

Take care not to spill fuel while fueling and do not overfill the tank.

STIHL recommends you use the STIHL filler nozzle for fuel (special accessory).

- Fill up with fuel.

Close the tank cap.

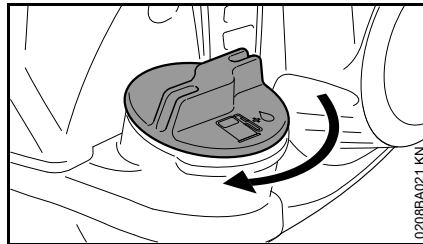

0208BA021 KN

- Place the cap in the opening.
- Turn the cap clockwise as far as stop and tighten it down as firmly as possible by hand.

Adjusting the Cutter Bar

Angle Adjuster - 145°

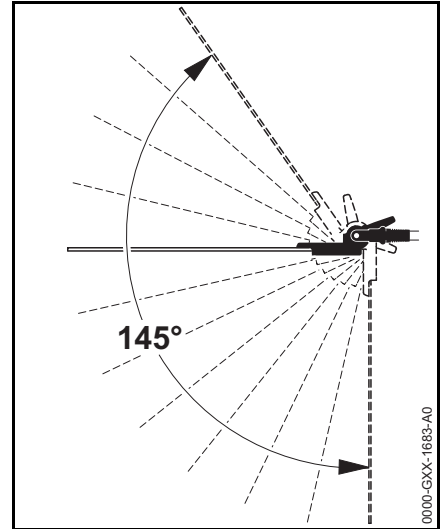

0000-GXX-1683-A0

The angle of the cutter bar can be adjusted upwards in 4 stages from 0° (straight) to 55°, and downwards in 7 stages from 0° to 90° (right angle facing down). There are therefore 12 possible working positions.

! WARNING

To reduce the risk of injury, carry out the adjustment only when the cutting blades are at a standstill – engine at idle speed.

! WARNING

The gearbox gets hot during operation. To reduce the risk of burn injury, do not touch the gearbox.

! WARNING

To reduce the risk of injury, never touch the blades while making adjustments.

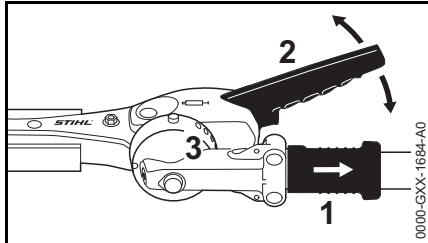

- Pull back the sliding sleeve (1) and use the lever (2) to adjust the joint by one or several holes.
- Release the sliding sleeve (1) and make sure the lock pin engages the quadrant (3).

Transport Position

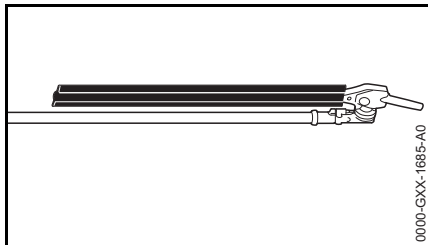

The cutter bar can be folded flat against the drive tube and locked in position to save space during transportation.

! WARNING

To reduce the risk of injury, always shut off the engine – depress stop switch – and fit the blade scabbard before

moving the cutter bar to the transport position or from the transport position to the normal working position.

! WARNING

The gearbox gets hot during operation. To reduce the risk of burn injury, do not touch the gearbox.

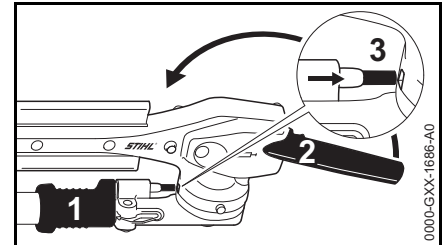

- Shut off the engine.
- Fit the blade scabbard.
- Pull back the sliding sleeve (1) and use the lever (2) to swing the joint upwards – in direction of drive tube – until the cutter bar is flat against the drive tube.
- Release the sliding sleeve (1) and make sure the lock pin engages the quadrant (3).

Fitting the Harness

Some versions of the machine can be carried on a shoulder strap.

The type and style of the shoulder strap depend on the market.

Shoulder Strap

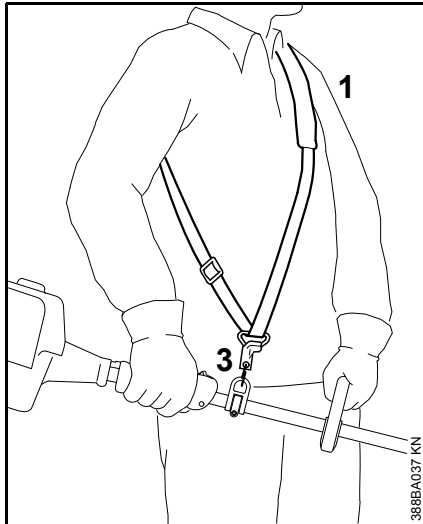

- Put on the shoulder strap (1).
- Adjust the length of the strap.
- With the power tool attached, the carabiner (3) must be at about the same height as your right hip.

Attaching Machine to Shoulder Strap

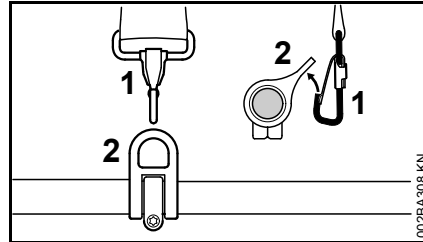

- Attach the carabiner (1) to the carrying ring (2) on the drive tube – hold the carrying ring steady.

Disconnecting Machine from Shoulder Strap

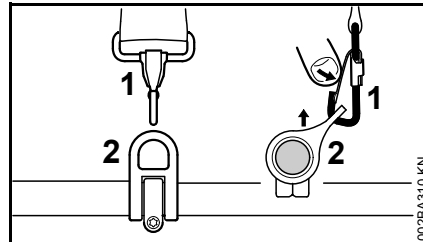

- Press down the bar on the carabiner (1) and pull the carrying ring (2) out of the carabiner.

Throwing Off the Machine

WARNING

The machine must be quickly thrown off in the event of imminent danger. Practice removing and putting down the machine as you would in an emergency. To avoid damage, do not throw the machine to the ground when practicing.

Practice quickly detaching the power tool from the carabiner as described under "Disconnecting Machine from Shoulder Strap".

If you are using a shoulder strap: Practice slipping the strap off your shoulder.

Starting / Stopping the Engine

Controls

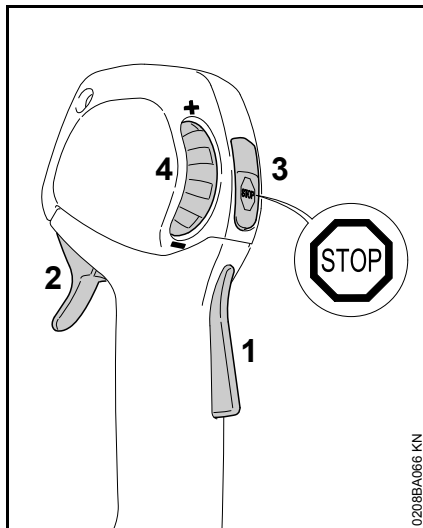

- 1 Throttle trigger lockout
- 2 Throttle trigger
- 3 Stop switch with **Run** and **Stop** positions. Depress the stop switch (⊖) to switch off the ignition – see "Function of Stop Switch and Ignition System".
- 4 Throttle set wheel – limits travel of throttle trigger – see "Function of Throttle Set Wheel".

Function of Stop Switch and Ignition System

The ignition is switched off and the engine stopped when the stop switch is pressed. The stop switch returns automatically to the **Run** position when it

is released: The ignition is switched on again after the engine stops – the engine is then ready to start.

Function of Throttle Set Wheel

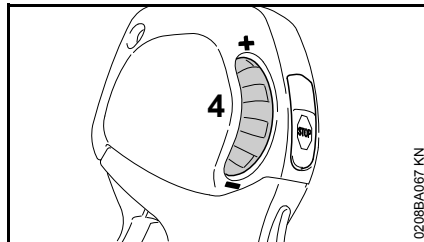

The throttle set wheel (4) enables the travel of the throttle trigger to be preset anywhere between idle and full throttle.

- Turn throttle set wheel (4) in direction of - to reduce throttle trigger travel and maximum engine speed.
- Turn throttle set wheel (4) in direction of + to increase throttle trigger travel and maximum engine speed.
- It is possible to override the preset stop and open the throttle wide by pulling the throttle trigger firmly – the preset stop remains unaffected. The original setting is restored when the throttle trigger is released.

Starting the Engine

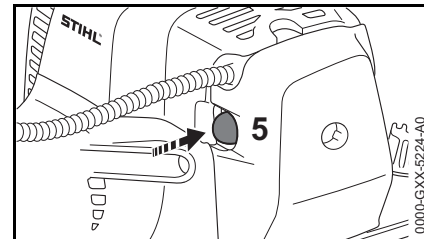

- Press the manual fuel pump bulb (5) at least five times – even if the bulb is already filled with fuel.

Cold engine (cold start)

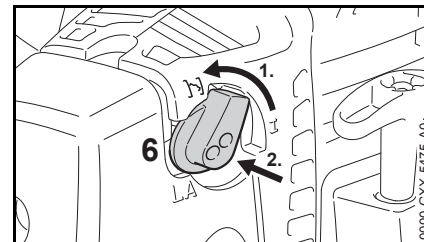

- Turn choke knob (6) and then push it in at **I**

Also use this setting if the engine has been running but is still cold.

- Turn throttle set wheel in direction of + as far as stop.

Hot engine (hot start)

- Choke knob (6) remains in **I** position.

Cranking

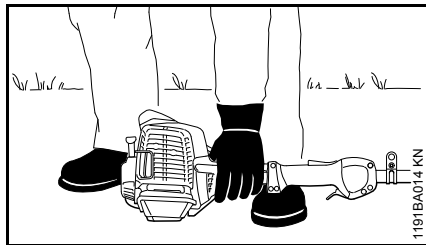

- Place the machine on the ground: It must rest securely on the engine support and the gearbox housing.
- On units with an adjustable cutter bar and defined transport position: Set the cutter bar to the straight (0°) position.
- If fitted: Remove blade scabbard from the cutting blades.

To reduce the risk of accidents, check that the cutting blades are not touching the ground of any other obstacles.

- Make sure you have a firm footing, either standing, stooping or kneeling.
- Hold the machine **firmly** on the ground with your left hand and press down – do not touch the throttle trigger, lockout lever or stop switch.



NOTICE

Do not stand or kneel on the shaft.

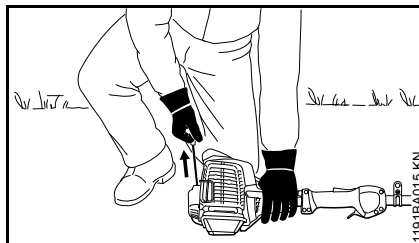

- Hold the starter grip with your right hand.

Version without ErgoStart

- Pull the starter grip slowly until you feel it engage and then give it a brisk strong pull.

Version with ErgoStart (C-E)

- Pull the starter rope slowly and steadily.



NOTICE

Do not pull out the starter rope all the way – **it might otherwise break**.

- Do not let the starter grip snap back. Guide it slowly back into the housing so that the starter rope can rewind properly.
- Continue cranking until the engine runs.

As soon as the engine runs

At temperatures below +10°C

Warm up the engine for at least 10 seconds in position **I**.

At temperatures above +10°C

Warm up the engine for at least 5 seconds in position **I**.

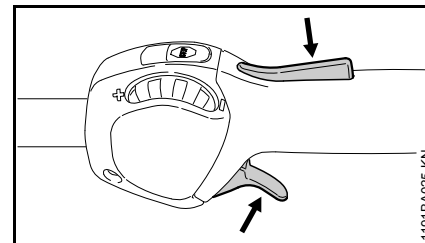

- Depress throttle trigger lockout and pull the throttle trigger – the choke knob moves to the run position **I**.

Warm up a **cold engine** at varying speeds.



WARNING

Make sure the carburetor is correctly adjusted. The cutting blades must not move when the engine is idling.

Your machine is now ready for operation.

Stopping the Engine

- Depress the momentary contact stop switch – the engine stops – release the stop switch – it springs back to the run position.

Other Hints on Starting

Engine stalls in cold start position **I**.

- Depress throttle trigger lockout and pull the throttle trigger – the choke knob moves to the run position **I**.
- Continue cranking in position **I** until the engine runs.

Running engine stalls in cold start position **I** or under acceleration.

- Continue cranking in position **I** until the engine runs.

If the engine does not start

- Check that all settings are correct.
- Check that there is fuel in the tank and refuel if necessary.
- Check that the spark plug boot is properly connected.
- Repeat the starting procedure.

Engine is flooded

- Move the choke knob to **I** and continue cranking until the engine runs.

Fuel tank run until completely dry

- After refueling, depress the manual fuel pump bulb at least 5 times – even if the bulb is already filled with fuel.
- Set the choke knob according to engine temperature.
- Now start the engine.

Operating Instructions

During break-in period

A factory-new machine should not be run at high revs (full throttle off load) for the first three tank fillings. This avoids unnecessary high loads during the break-in period. As all moving parts have to bed in during the break-in period, the frictional resistances in the engine are greater during this period. The engine develops its maximum power after about 5 to 15 tank fillings.

During Operation

After a long period of full throttle operation, allow the engine to run for a short while at idle speed so that engine heat can be dissipated by the flow of cooling air. This protects engine-mounted components (ignition, carburetor) from thermal overload.

After Finishing Work

Storing for a short period: Wait for the engine to cool down. Empty the fuel tank and keep the machine in a dry place, well away from sources of ignition, until you need it again. For longer out-of-service periods – see "Storing the Machine".

Cleaning the Air Filter

If there is a noticeable loss of engine power

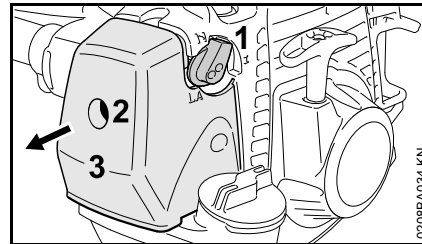

- Set knob for warm start (1) to **I**
- Turn screw (2) in filter cover (3) counterclockwise until the cover is loose
- Remove filter cover (3)
- Clean away loose dirt from around the filter

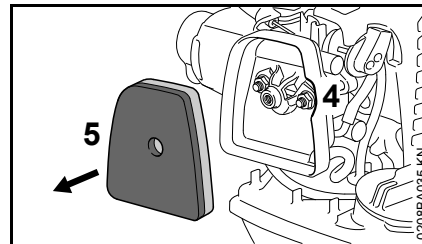

- Grip into the recess (4) in the filter housing and remove the felt filter (5)
- Replace felt filter (5) – as a temporary measure you can knock it out on the palm of your hand or blow it out with compressed air – do not wash

 NOTICE

Replace any damaged parts!

- Insert felt filter (5) form-fittingly into the filter housing
- Set knob for warm start (1) to \overline{I}
- Fit filter cover (3) – make sure not to tilt the screw (2) – insert screw and tighten

Adjusting the Carburetor

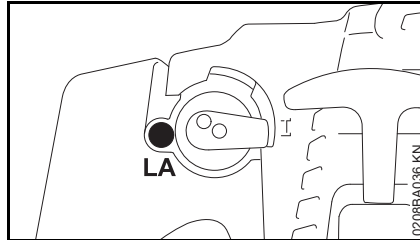

The carburetor of the machine has been adjusted at the factory for optimum performance and fuel efficiency in all operating states.

Setting the idle speed

Engine stops when idling

- Turn the idle speed screw (LA) slowly clockwise until the engine runs smoothly.

Cutting blades move when idling

- Turn the idle speed adjusting screw (LA) slowly counterclockwise until the cutting blades stop moving

WARNING

If the cutting blades continue to move in idle even after adjustment, have the machine repaired by a STIHL servicing dealer.

Spark Plug

- If the engine is down on power, difficult to start or runs poorly at idle speed, first check the spark plug.
- Fit a new spark plug after about 100 operating hours – or sooner if the electrodes are badly eroded. Install only suppressed spark plugs of the type approved by STIHL – see "Specifications".

Removing the spark plug

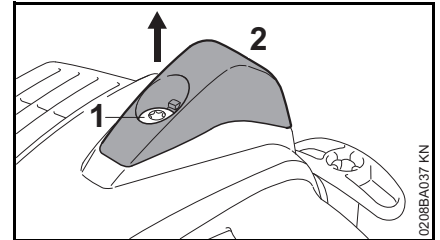

- Turn screw (1) in cap (2) until cap can be removed
- Lay down cap

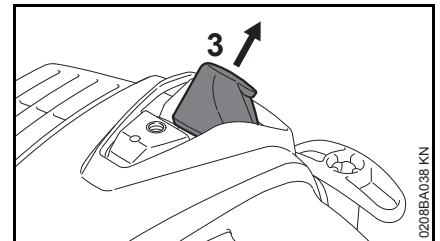

- Pull off the spark plug boot (3)
- Unscrew spark plug,

Checking the Spark Plug

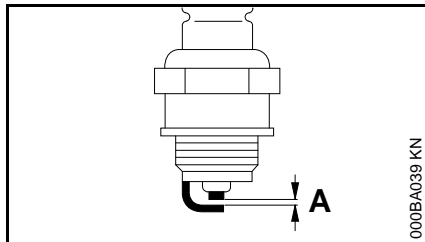

- Clean dirty spark plug.
- Check electrode gap (A) and readjust if necessary – see "Specifications".
- Rectify the problems which have caused fouling of the spark plug.

Possible causes are:

- Too much oil in fuel mix.
- Dirty air filter.
- Unfavorable running conditions.

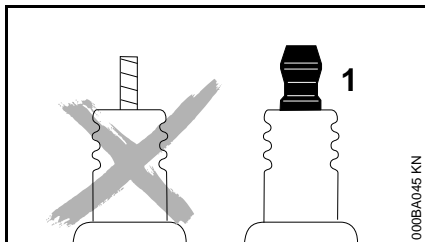

WARNING

Arcing may occur if the adapter nut (1) is loose or missing. Working in an easily combustible or explosive atmosphere may cause a fire or an explosion. This can result result in serious injuries or damage to property.

- Use resistor type spark plugs with a properly tightened adapter nut.

Installing the spark plug

- Fit the spark plug and tighten it down firmly
- Press spark plug boot **firmly** onto spark plug

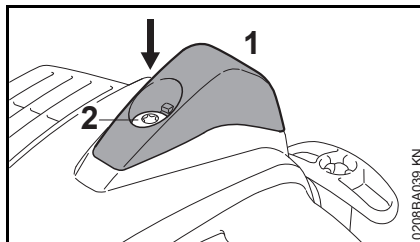

- Fit cap (1), insert and tighten screw (2)

Lubricating the Gearbox



Blade Drive Gear

Lubricate the blade drive gear with STIHL gear lubricant for hedge trimmers – see "Special Accessories".

HL 0° version

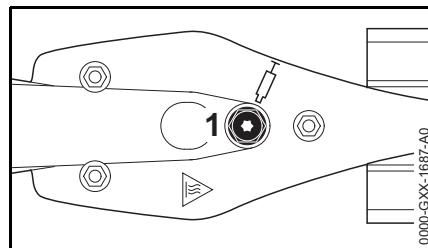

Adjustable HL 145° version

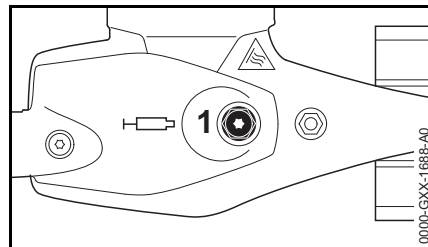

- Check the lubricant level at regular intervals of about every 25 hours of operation. Unscrew the filler

plug (1) – if no grease can be seen on the inside of the filler plug, screw the tube of grease into the filler hole.

- Squeeze up to 10 g (2/5 oz) grease into the gearbox.

**NOTICE**

Do not completely fill the gearbox with grease.

- Unscrew the tube of grease from the filler hole.
- Refit the filler plug and tighten it down firmly.

Angle Drive Gear

Lubricate the angle drive gear with STIHL gear lubricant for hedge trimmers (special accessory).

Adjustable HL 145° version

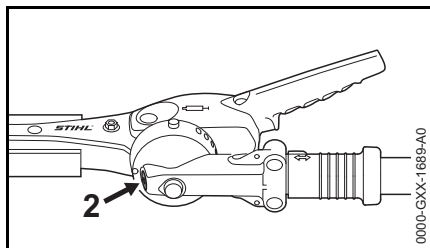

- Check the lubricant level at regular intervals of about every 25 hours of operation. Unscrew the filler plug (2) – if no grease can be seen on the inside of the filler plug, screw the tube of grease into the filler hole.
- Squeeze up to 5 g (1/5 oz) grease into the gearbox.

**NOTICE**

Do not completely fill the gearbox with grease.

- Unscrew the tube of grease from the filler hole.
- Refit the filler plug and tighten it down firmly.

Sharpening Instructions

When cutting performance and behavior begin to deteriorate, i.e. blades frequently snag on branches: Resharpener the cutting blades.

It is best to have the cutting blades resharpened by a dealer on a workshop sharpener. STIHL recommends an authorized STIHL servicing dealer.

It is also possible to use a flat crosscut sharpening file. Hold the sharpening file at the prescribed angle (see "Specifications").

- Only sharpen the cutting edge.
- Always file towards the cutting edge.
- The file only sharpens on the forward stroke – lift it off the blade on the backstroke.
- Use a whetstone to remove burr from cutting edges.
- Remove as little material as possible.
- After sharpening, clean away filing or grinding dust and then spray the cutting blades with STIHL resin solvent.

**NOTICE**

Do not operate your machine with dull or damaged cutting blades. This may cause overload and will give unsatisfactory cutting results.

Storing the Machine

For periods of about 3 months or longer

- Drain and clean the fuel tank in a well ventilated area.
- Dispose of fuel properly in accordance with local environmental requirements.
- Run the engine until the carburetor is dry – this helps prevent the carburetor diaphragms sticking together.
- Clean the cutting blades, check condition and spray them with STIHL resin solvent.
- Fit the blade scabbard.
- Thoroughly clean the machine.
- Store the machine in a dry and secure location. Keep out of the reach of children and other unauthorized persons.

Inspection and Maintenance by User

Throttle Cable

Checking adjustment of throttle cable

Error: Engine speed increases when only the throttle trigger is pulled.

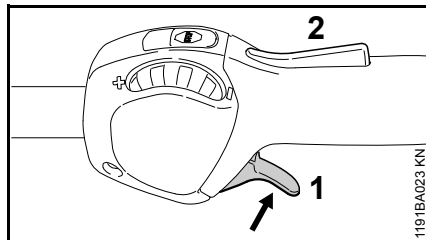

- Start the engine.
- Pull the throttle trigger (1) – **do not** press down the throttle trigger lockout (2).

If the engine speed increases or if the cutting blades run, the throttle cable has to be adjusted.

- Shut off the engine.
- Have throttle cable adjusted by your dealer. STIHL recommends an authorized STIHL servicing dealer.

Inspections and Maintenance by Dealer

Maintenance Work

STIHL recommends that you have servicing and repair work carried out exclusively by an authorized STIHL servicing dealer.

Antivibration Element

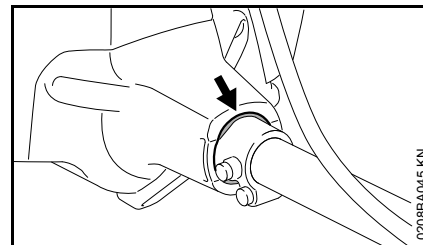

A vibration-absorbing rubber element is installed between the powerhead and the shaft. Have it checked if there are signs of wear or a noticeable increase in vibration levels.

Maintenance and Care

| The following intervals apply to normal operating conditions only. If your daily working time is longer or operating conditions are difficult (very dusty work area, etc.), shorten the specified intervals accordingly. | | before starting work | after finishing work or daily | after each refueling stop | weekly | monthly | every 12 months | if problem | if damaged | as required |
|--|--|----------------------|-------------------------------|---------------------------|--------|---------|-----------------|------------|------------|-------------|
| | | | | | | | | | | |
| Complete machine | Visual inspection (condition, leaks) | X | | X | | | | | | |
| | Clean | | X | | | | | | | |
| | Replace any damaged parts | X | | | | | | | | |
| Control handle | Check operation | X | | X | | | | | | |
| Air filter | Visual inspection | | | | | X | | X | | |
| | Clean filter housing | | | | | | | | | X |
| | Replace felt filter ¹⁾ | | | | | | | | X | X |
| Fuel tank | Clean | | | | | X | | X | | X |
| Manual fuel pump (if fitted) | Check | X | | | | | | | | |
| | Have repaired by servicing dealer ²⁾ | | | | | | | | X | |
| Pickup body in fuel tank | Have checked by servicing dealer ²⁾ | | | | | | | X | | |
| | Have replaced by servicing dealer ²⁾ | | | | | | X | | X | X |
| Carburetor | Check idle setting, the cutting blades must not move | X | | X | | | | | | |
| | Adjust idle speed | | | | | | | | | X |
| Spark plug | Adjust electrode gap | | | | | | | X | | |
| | Replace after every 100 operating hours | | | | | | | | | |
| Cooling inlet | Visual inspection | | X | | | | | | | |
| | Clean | | | | | | | | | X |
| Cylinder fins | Have cleaned by servicing dealer ²⁾ | | | | | | X | | | |
| Exhaust port | Have decoked by servicing dealer ²⁾ after first 139 hours of operation, then every 150 hours of operation | | | | | | | | | X |
| All accessible screws and nuts (not adjusting screws) | Retighten | | | | | | | | | X |

| The following intervals apply to normal operating conditions only. If your daily working time is longer or operating conditions are difficult (very dusty work area, etc.), shorten the specified intervals accordingly. | | before starting work | after finishing work or daily | after each refueling stop | weekly | monthly | every 12 months | if problem | if damaged | as required |
|--|---|----------------------|-------------------------------|---------------------------|--------|---------|-----------------|------------|------------|-------------|
| Anti-vibration elements | Visual inspection ³⁾ | X | | | | | | X | | X |
| | Have replaced by servicing dealer ²⁾ | | | | | | | | X | |
| Cutting blades | Visual inspection | X | | X | | | | | | |
| | Clean ⁴⁾ | | X | | | | | | | |
| | Sharpen ⁴⁾ | | | | | | | | X | X |
| Gearbox lubrication | Check | X | | | | | | | | |
| | Replenish | | | | | | | | | X |
| Safety labels | Replace | | | | | | | | X | |
| ¹⁾ Only if there is a noticeable loss of engine power ²⁾ STIHL recommends an authorized STIHL servicing dealer. ³⁾ see chapter "Inspections and Maintenance by Dealer", section "Antivibration Elements" ⁴⁾ Spray with STIHL resin solvent after cleaning | | | | | | | | | | |

Minimize Wear and Avoid Damage

Observing the instructions in this manual helps reduce the risk of unnecessary wear and damage to the power tool.

The power tool must be operated, maintained and stored with the due care and attention described in this owner's manual.

The user is responsible for all damage caused by non-observance of the safety precautions, operating and maintenance instructions in this manual. This includes in particular:

- Alterations or modifications to the product not approved by STIHL.
- Using tools or accessories which are neither approved or suitable for the product or are of a poor quality.
- Using the product for purposes for which it was not designed.
- Using the product for sports or competitive events.
- Consequential damage caused by continuing to use the product with defective components.

Maintenance Work

All the operations described in the "Maintenance Chart" must be performed on a regular basis. If these maintenance operations cannot be performed by the owner, they should be performed by a servicing dealer.

STIHL recommends that you have servicing and repair work carried out exclusively by an authorized STIHL

servicing dealer. STIHL dealers are regularly given the opportunity to attend training courses and are supplied with the necessary technical information.

If these maintenance operations are not carried out as specified, the user assumes responsibility for any damage that may occur. Among other parts, this includes:

- Damage to the engine due to neglect or deficient maintenance (e.g. air and fuel filters), incorrect carburetor adjustment or inadequate cleaning of cooling air inlets (intake ports, cylinder fins).
- Corrosion and other consequential damage resulting from improper storage.
- Damage to the machine resulting from the use of poor quality replacement parts.

Parts Subject to Wear and Tear

Some parts of the power tool are subject to normal wear and tear even during regular operation in accordance with instructions and, depending on the type and duration of use, have to be replaced in good time. Among other parts, this includes:

- Cutting blades
- Clutch
- Filters (air, fuel)
- Rewind starter
- Spark plug
- Components of antivibration system

Main Parts

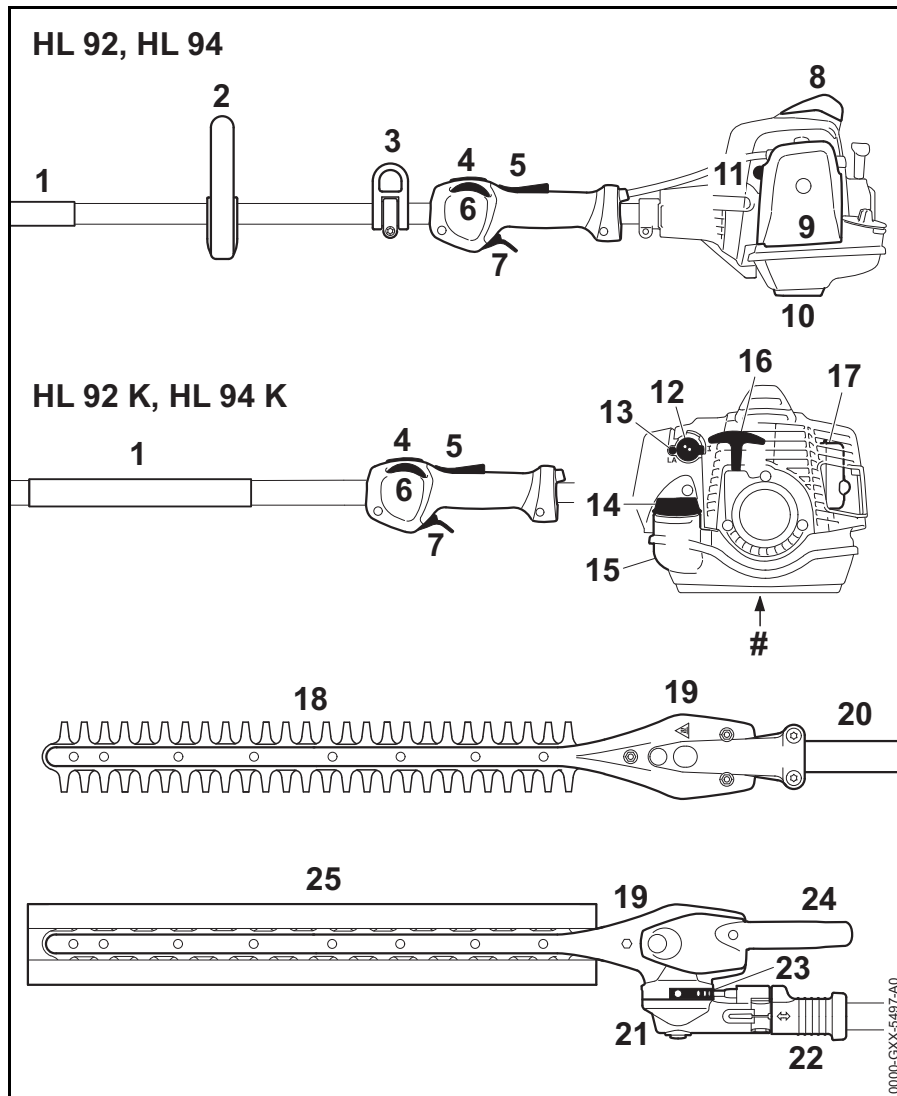

- 1 Handle hose
- 2 Loop handle
- 3 Carrying ring
- 4 Stop switch
- 5 Throttle trigger lockout
- 6 Set wheel
- 7 Throttle trigger
- 8 Spark plug boot with cap
- 9 Air filter cover
- 10 Machine support
- 11 Manual fuel pump
- 12 Choke knob
- 13 Carburetor adjusting screw
- 14 Tank cap
- 15 Fuel tank
- 16 Starter grip
- 17 Muffler
- 18 Cutting blade
- 19 Blade drive gear
- 20 Drive tube
- 21 Angle drive
- 22 Sliding sleeve
- 23 Quadrant
- 24 Adjusting lever
- 25 Blade scabbard
- # Serial number

0000-GXX-5487-A0

Specifications

Engine

Single cylinder two-stroke engine

| | |
|---------------------------|-------------------------------|
| Displacement: | 24.1 cc |
| Bore: | 35 mm |
| Stroke: | 25 mm |
| Engine power to ISO 8893: | 0.9 kW (1.2 bhp) at 8,000 rpm |
| Idle speed: | 2,800 rpm |
| Cut-off speed (rated): | 9,300 rpm |

Ignition System

Electronic magneto ignition

| | |
|-----------------------------|-----------|
| Spark plug (resistor type): | NGK CMR6H |
| Electrode gap: | 0.5 mm |

Fuel System

| | |
|---------------------|-----------------|
| Fuel tank capacity: | 540 cc (0.54 l) |
|---------------------|-----------------|

Weight

| | |
|------------------------------------|--------|
| Dry weight with 0° gearbox, 500 mm | |
| HL 94: | 5.6 kg |
| HL 94 K: | 5.1 kg |
| Dry weight with 0° gearbox, 600 mm | |
| HL 94: | 5.8 kg |
| HL 94 K: | 5.3 kg |

Dry weight with 145° adjustable gearbox, 500 mm

| | |
|----------|--------|
| HL 94: | 6.0 kg |
| HL 94 K: | 5.5 kg |

Dry weight with 145° adjustable gearbox, 600 mm

| | |
|----------|--------|
| HL 94: | 6.1 kg |
| HL 94 K: | 5.6 kg |

Cutting blade

| | |
|-------------------|--|
| Type: | Double-edged for bidirectional cutting |
| Cutting length: | 500 mm, 600 mm |
| Tooth spacing: | 34 mm |
| Tooth height: | 22 mm |
| Sharpening angle: | 45° to horizontal |

Noise and Vibration Data

Noise and vibration data are measured at idling and maximum rated speed in a ratio of 1:4.

For further details on compliance with Vibration Directive 2002/44/EEC see www.stihl.com/vib/

Sound pressure level L_p to ISO 22868

| | |
|----------|----------|
| HL 94: | 91 dB(A) |
| HL 94 K: | 92 dB(A) |

Sound power level L_w to ISO 22868

| | |
|----------|-----------|
| HL 94: | 107 dB(A) |
| HL 94 K: | 108 dB(A) |

HL 0°, 500 mm / HL 0°, 600 mm / HL 145°, 500 mm / HL 145°, 600 mm

Vibration level $a_{hv,eq}$ to ISO 22867:

HL 94, left hand on handle hose:

| | |
|-----------------|----------------------|
| Handle hose: | 4.1 m/s ² |
| Control handle: | 4.5 m/s ² |

Vibration level $a_{hv,eq}$ to ISO 22867:

HL 94, left hand on loop handle:

| | |
|-----------------|----------------------|
| Loop handle: | 6.1 m/s ² |
| Control handle: | 5.4 m/s ² |

HL 0° 500 mm:

Vibration level $a_{hv,eq}$ to ISO 22867:

| | |
|-----------------|----------------------|
| HL 94 K: | |
| Handle hose: | 6.2 m/s ² |
| Control handle: | 5.9 m/s ² |

HL 0° 600 mm:

Vibration level $a_{hv,eq}$ to ISO 22867:

| | |
|-----------------|----------------------|
| HL 94 K: | |
| Handle hose: | 6.0 m/s ² |
| Control handle: | 6.5 m/s ² |

HL 145° 500 mm:

Vibration level $a_{hv,eq}$ to ISO 22867:

| | |
|-----------------|----------------------|
| HL 94 K: | |
| Handle hose: | 7.0 m/s ² |
| Control handle: | 7.2 m/s ² |

HL 145° 600 mm:

Vibration level $a_{hv,eq}$ to ISO 22867:

| | |
|-----------------|----------------------|
| HL 94 K: | |
| Handle hose: | 6.4 m/s ² |
| Control handle: | 6.4 m/s ² |

The noise and vibration data of the approved attachments are listed in the instructions supplied with each attachment.

The K-factor in accordance with Directive 2006/42/EC is 2.0 dB(A) for the sound pressure level and sound power level; the K-factor in accordance with Directive 2006/42/EC is 2.0 m/s² for the vibration level.

REACH

REACH is an EC regulation and stands for the Registration, Evaluation, Authorisation and Restriction of Chemical substances.

For information on compliance with the REACH regulation (EC) No. 1907/2006 see www.stihl.com/reach.

Exhaust Emissions

The CO₂ value measured in the EU type approval procedure is specified at www.stihl.com/co2.

The measured CO₂ value was determined on a representative engine in accordance with a standardized test procedure under laboratory conditions and does not represent either an explicit or implied guarantee of the performance of a specific engine.

The applicable exhaust emission requirements are fulfilled by the intended usage and maintenance described in this instruction manual. The type approval expires if the engine is modified in any way.

Maintenance and Repairs

Users of this machine may only carry out the maintenance and service work described in this user manual. All other repairs must be carried out by a servicing dealer.

STIHL recommends that you have servicing and repair work carried out exclusively by an authorized STIHL servicing dealer. STIHL dealers are regularly given the opportunity to attend training courses and are supplied with the necessary technical information.

When repairing the machine, only use replacement parts which have been approved by STIHL for this power tool or are technically identical. Only use high-quality replacement parts in order to avoid the risk of accidents and damage to the machine.

STIHL recommends the use of original STIHL replacement parts.

Original STIHL parts can be identified by the STIHL part number, the **STIHL** logo and the STIHL parts symbol  (the symbol may appear alone on small parts).

Disposal

Observe all country-specific waste disposal rules and regulations.

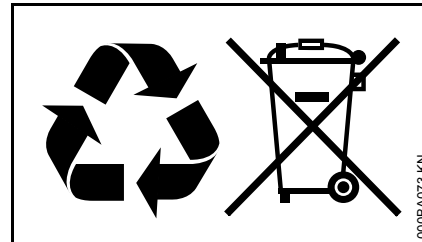

STIHL products must not be thrown in the garbage can. Take the product, accessories and packaging to an approved disposal site for environment-friendly recycling.

Contact your STIHL servicing dealer for the latest information on waste disposal.

EC Declaration of Conformity

ANDREAS STIHL AG & Co. KG
 Badstr. 115
 D-71336 Waiblingen
 Germany

declare in exclusive responsibility that

Category: Long reach
 hedge trimmer
 Make: STIHL
 Model: HL 94
 HL 94 K
 Serial identification: 4243
 Displacement
 All HL 94 models: 24.1 cc

conforms to the relevant provisions of Directives 2006/42/EC, 2014/30/EU and 2000/14/EC and has been developed and manufactured in compliance with the following standards in the versions valid on the date of production:

EN ISO 10517, EN 55012,
 EN 61000-6-1

The measured and guaranteed sound power levels were determined according to Directive 2000/14/EC, Annex V, using the ISO 11094 standard.

Measured sound power level

All HL 94 models: 101 dB(A)
 all HL 94 K models: 101 dB(A)

Guaranteed sound power level

All HL 94 models: 103 dB(A)
 all HL 94 K models: 103 dB(A)

Technical documents deposited at:

HL 94, HL 94 K

ANDREAS STIHL AG & Co. KG
 Produktzulassung (Product Licensing)

The year of manufacture and serial number are applied to the product.

Done at Waiblingen, 01.11.2017

ANDREAS STIHL AG & Co. KG



Thomas Elsner

Director Product Management and Services



0458-519-0121-D

englisch



www.stihl.com



0458-519-0121-D