

Hedge Trimmer Safety Manual

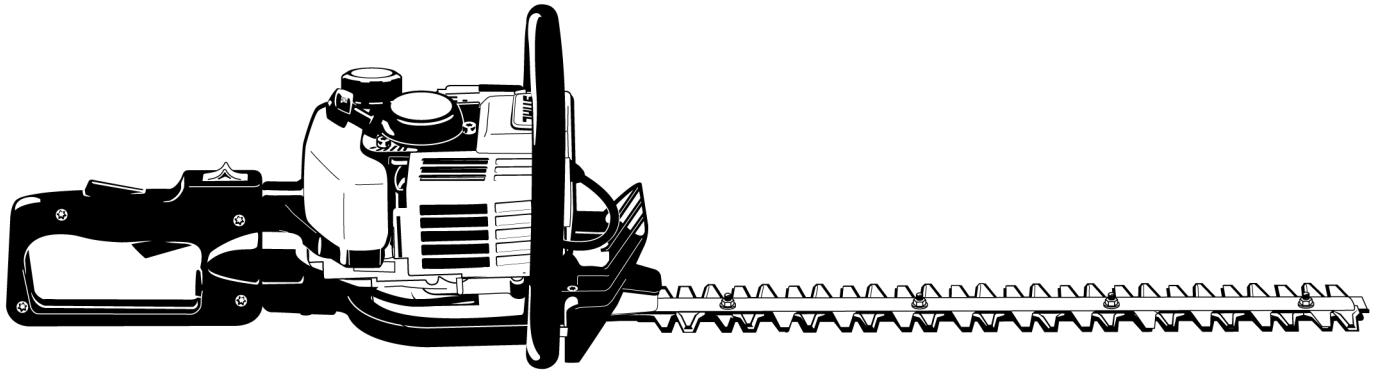

Contents

Safety Precautions and Working Techniques	2
Using the Unit	7
Maintenance and Care	9
Main Parts	11

This manual contains the safety precautions and recommended cutting techniques outlined in the instruction manuals for STIHL hedge trimmers.

The chapters on "Using the Unit" and "Parts and Controls" show model HS 81 as an example.

Other hedge trimmer models may have different parts and controls.

This manual contains references to various chapters in the model-specific instruction manuals.

You should therefore always refer to the instruction manual of your particular hedge trimmer model.

Please contact your STIHL dealer if you have any further questions after reading this manual.

Original Instruction Manual

Printed on chlorine-free paper
Printing inks contain vegetable oils, paper can be recycled.

© ANDREAS STIHL AG & Co. KG, 2012
0457-189-0121 - VA0A12.
0000000557_001_GB



Safety Precautions and Working Techniques



Special safety precautions must be observed when working with this power tool because it has very sharp, high-speed cutting blades.



It is important you read and understand the instruction manual before using your unit for the first time and keep the manual in a safe place for future reference. Non-observance of the safety precautions may result in serious or even fatal injury.

Observe all application local safety regulations, standards and ordinances.

If you have not used this type of power tool before: Have your dealer or other experienced user show you how to operate your power tool or attend a special course in power tool operation.

Minors should never be allowed to use a power tool.

Bystanders, especially children, and animals should not be allowed in the area where a power tool is in use.

When the power tool is not in use, shut it off so that it does not endanger others. Secure it against unauthorized use.

The user is responsible for avoiding injury to third parties or damage to their property.

Do not lend or rent your power tool without the instruction manual. Be sure that anyone using it understands the information contained in this manual.

The use of noise emitting power tools may be restricted to certain times by national or local regulations.

To operate the power tool you must be rested, in good physical condition and mental health.

If you have any condition that might be aggravated by strenuous work, check with your doctor before operating a power tool.

Persons with pacemakers only: The ignition system of your power tool produces an electromagnetic field of a very low intensity. This field may interfere with some pacemakers. To reduce health risks, STIHL recommends that persons with pacemakers consult their physician and the pacemaker manufacturer before operating this tool.

Do not operate the power tool if you are under the influence of any substance (drugs, alcohol) which might impair visions, dexterity or judgment.

Use your hedge trimmer only for cutting hedges, shrubs, scrub and similar materials.

It must not be used for any other purpose because of the increased risk of accidents and damage to the machine. Never attempt to modify your power tool in any way since this may result in accidents or damage to the machine.

Only use parts and accessories that are explicitly approved for this power tool by STIHL or are technically identical. If you have any questions in this respect,

consult a servicing dealer. Use only high quality parts and accessories in order to avoid the risk of accidents and damage to the machine.

STIHL recommends the use of genuine STIHL replacement parts. They are specifically designed to match your model and meet your performance requirements.

Never attempt to modify your power tool in any way since this will increase the risk of personal injury. STIHL excludes all liability for personal injury and damage to property caused while using unauthorized attachments.

Do not use a pressure washer to clean the power tool. The solid jet of water may damage parts of the tool.

Clothing and Equipment

Wear proper protective clothing and equipment.



Clothing must be sturdy but allow complete freedom of movement. Wear snug-fitting clothing, an overall and jacket combination, do not wear a work coat.

Avoid clothing that could get caught on branches or brush or moving parts of the machine. Do not wear a scarf, necktie or jewelry. Tie up and confine long hair (e.g. with a hair net, cap, hard hat, etc.).

Wear sturdy shoes with non-slip soles.



Wear safety glasses and hearing protection, e.g. earplugs or ear muffs.



Wear heavy-duty gloves.

STIHL offers a comprehensive range of personal protective clothing and equipment.

Transporting the Power Tool

Always turn off the engine.

Always fit the blade guard (scabbard) before carrying your hedge trimmer short distances.

Carry the power tool by the handle – cutting blades behind you. Avoid touching hot parts of the machine, especially the muffler and gear housing – you could suffer serious burns.

Transporting in a vehicle: Properly secure your power tool to prevent turnover, fuel spillage and damage.

Fueling



Gasoline is an extremely flammable fuel. Keep clear of naked flames. Do not spill any fuel – do not smoke.

Always **shut off the engine** before refueling.

Do not fuel a hot engine – fuel may spill and cause a fire.

Open the fuel cap carefully to allow any pressure build-up in the tank to release slowly and avoid fuel spillage.

Fuel your power tool only in well-ventilated areas. If you spill fuel, wipe the machine immediately – if fuel gets on your clothing, change immediately.

Your power tool comes standard with either a screw-type or bayonet-type fuel cap.



After fueling, tighten down the screw-type fuel cap as securely as possible.



Insert the fuel cap with hinged grip (bayonet-type cap) correctly in the opening, turn it clockwise as far as stop and fold the grip down.

This reduces the risk of unit vibrations causing the fuel cap to loosen or come off and spill quantities of fuel.

To reduce the **risk of serious of fatal burn injuries**, check for fuel leakage. If fuel leakage is found, do not start or run the engine until leak is fixed.

Before Starting

Check that your power tool is properly assembled and in good condition – refer to appropriate chapters in the instruction manual.

- Engage the blade lock (if fitted).
- Slide control / stop switch must move easily to **STOP** or **0**
- Smooth action of throttle trigger interlock and throttle trigger – the throttle trigger must return automatically to the idle position.
- Check that the spark plug boot is secure – a loose boot may cause arcing that could ignite combustible fumes and cause a fire.
- Cutting blades securely mounted and in good condition (clean, move freely, not warped), properly sharpened and thoroughly sprayed with STIHL resin solvent (lubricant).
- Check cutter guard (if fitted) for damage.
- Never attempt to modify the controls or the safety devices in any way.
- Keep the handles dry and clean – free from oil and dirt – for safe control of the power tool.

To reduce the risk of personal injury, do not operate your power tool if it is damaged or not properly assembled.

Starting the Engine

Start the engine at least 3 meters from the fueling spot, outdoors only.

Place the unit on firm ground in an open area. Make sure you have good balance and secure footing. Hold the unit securely. The cutting blades must be clear of the ground and all other obstructions because they may begin to run when the engine starts.

Your power tool is designed to be operated by one person only. Do not allow other persons in the work area – even when starting.

To reduce the risk of injury, avoid contact with the cutting blades.

Do not drop start the power tool – start the engine as described in the instruction manual.

Note that the cutting blades continue to run for a short period after you let go of the throttle trigger (flywheel effect).

Check idle speed setting: The cutting blades must not move when the engine is idling with the throttle trigger released.

Holding and Controlling the Unit

Always hold the unit firmly with both hands on the handles. Wrap your fingers and thumbs around the handles.

Right-handers

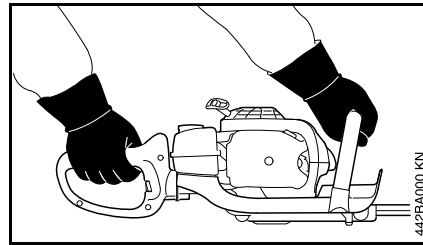

Right hand on the control handle and left hand on the front handle.

Left-handers

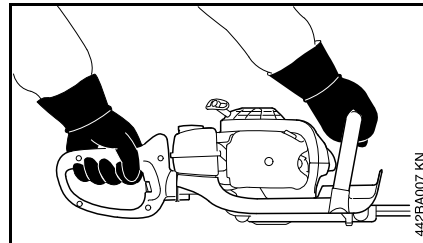

Left hand on the control handle and right hand on the front handle.

Make sure you have firm and secure footing and hold the unit so that the cutting blades are always away from your body.

During Operation

In the event of impending danger or in an emergency, switch off the engine immediately by moving the slide control / stop switch to **0** or **STOP**.

Check that there are no bystanders in the general work area.

Watch the cutting blades at all times – do not cut areas of the hedge that you cannot see.

Be extremely careful when cutting tall hedges, check the other side of the hedge before starting work.

Make sure the idle speed setting is correct. The cutting blades must not run when the engine is idling with the throttle trigger released.

If the cutting blades still run, have your dealer check your machine and make proper adjustments or repairs. Check and correct the idle speed setting at regular intervals.

Note that the cutting blades continue to run for a short period after you let go of the throttle trigger (flywheel effect).

The gearbox becomes hot during operation. To reduce the risk of burn injury, do not touch the gear housing.

Take special care in slippery conditions – damp, snow, ice, on slopes or uneven ground.

Clear away fallen branches, scrub and cuttings.

Watch out for obstacles: Roots, tree stumps or holes which could cause you to trip or stumble.

Make sure you always have good balance and secure footing.

When working at heights:

- Always use a lift bucket
- Never work on a ladder or in a tree
- Never work on an insecure support
- Never operate your unit with one hand

Be particularly alert and cautious when wearing hearing protection because your ability to hear warnings (shouts, alarms, etc.) is restricted.

To reduce the risk of accidents, take a break in good time to avoid tiredness or exhaustion.

Work calmly and carefully – in daylight conditions and only when visibility is good. Stay alert so as not to endanger others.



Your power tool produces toxic exhaust fumes as soon as the engine is running. These fumes may be colorless and odorless and contain unburned hydrocarbons and benzol. Never run the engine indoors or in poorly ventilated locations, even if your model is equipped with a catalytic converter.

To reduce the risk of serious or fatal injury from breathing toxic fumes, ensure proper ventilation when working in trenches, hollows or other confined locations.

To reduce the risk of accidents, stop work immediately in the event of nausea, headache, visual disturbances (e.g. reduced field of vision), problems with hearing, dizziness, deterioration in ability to concentrate. Apart from other possibilities, these symptoms may be caused by an excessively high concentration of exhaust gases in the work area.

Operate your power tool so that it produces a minimum of noise and emissions – do not run the engine unnecessarily, accelerate the engine only for cutting.

To reduce the risk of fire, do not smoke while operating or standing near your power tool. Note that combustible fuel vapor may escape from the fuel system.

If your power tool is subjected to unusually high loads for which it was not designed (e.g. heavy impact or a fall), always check that it is in good condition before continuing work – see also "Before Starting". Check the fuel system in particular for leaks and make sure the safety devices are working properly. Do not continue operating your power tool if it is damaged. In case of doubt, have the machine checked by your servicing dealer.

Do not operate your power tool with the starting throttle lock engaged – engine speed cannot be controlled in this position.

Inspect the hedge and work area to avoid damaging the cutting blades:

- Remove stones, rocks, pieces of metal and other solid objects.
- When working close to the ground, make sure that no sand, grit or stones get between the blades.
- Take particular care when cutting hedges next to or against wire fences.

To avoid the **risk of electrocution**, do not touch electric power lines – never cut through electric power lines.



Do not touch the cutting blades while the engine is running. If the cutting blades become jammed by thick branches or other obstructions, switch off the engine immediately before attempting to free the blades.

Opening the throttle while the blades are blocked increases the load and reduces engine speed. The clutch then slips continuously and this causes overheating and damage to important components (e.g. clutch, polymer housing components) – and this can increase the risk of injury from the blades moving while the engine is idling.

If the hedge is very dusty or dirty, spray the blades with STIHL resin solvent from time to time during cutting. This helps reduce blade friction as well as the aggressive effects of sap and the build-up of dirt particles.

The dust that occurs during operation may be harmful to health. If dust levels are very high, wear a suitable respirator.

Before leaving the power tool unattended: Shut off the engine.

Check the cutting blades at regular short intervals during operation or immediately if there is a noticeable change in cutting behavior:

- To shut down the engine
- Wait until the cutting blades have come to a complete standstill.
- Check condition and tightness, look for cracks.
- Check sharpness.

To reduce the risk of fire, always clean plant residue, chips, leaves and excess lubricant off the engine and muffler.

After Finishing Work

Always clean dust and dirt off the machine – do not use any grease solvents for this purpose.

Spray the blades with STIHL resin solvent. Run the engine briefly so that the solvent is evenly distributed.

Vibrations

Prolonged use of the power tool may result in vibration-induced circulation problems in the hands ("white finger disease").

No general recommendation can be given for the length of usage because it depends on several factors.

The period of usage is prolonged by:

- Hand protection (wearing warm gloves)
- Work breaks

The period of usage is shortened by:

- Any personal tendency to suffer from poor circulation (symptoms: frequently cold fingers, tingling sensation)
- Low outside temperatures
- Amount of gripping force (holding the power tool tightly restricts circulation)

Users who use the machine periodically or for long periods or users who repeatedly experience corresponding

symptoms (e.g., tingling sensation in fingers), should undergo a medical examination.

Maintenance and Repairs

Service the machine regularly. Do not attempt any maintenance or repair work not described in the instruction manual. Have all other work performed by a servicing dealer.

STIHL recommends that you have servicing and repair work carried out exclusively by an authorized STIHL servicing dealer. STIHL dealers are regularly given the opportunity to attend training courses and are supplied with the necessary technical information.

Only use high-quality replacement parts in order to avoid the risk of accidents and damage to the machine. If you have any questions in this respect, consult a servicing dealer.

STIHL recommends the use of genuine STIHL replacement parts. They are specifically designed to match your model and meet your performance requirements.

To reduce the risk of injury, **always shut off the engine** before carrying out any maintenance or repairs or cleaning the machine. – Exception: Carburetor and idle speed adjustments.

Do not turn the engine over on the starter with the spark plug boot or spark plug removed unless the slide control / stop switch is on **STOP** or **0** since there is otherwise a **risk of fire** from uncontained sparking.

To reduce the **risk of fire**, do not service or store your machine near open flames.

Check the fuel filler cap for leaks at regular intervals.

Use only a spark plug of the type approved by STIHL and make sure it is in good condition – see "Specifications".

Inspect the ignition lead (insulation in good condition, secure connection).

Check the condition of the muffler.

To reduce the **risk of fire and damage to hearing**, do not operate your machine if the muffler is damaged or missing.

Do not touch a hot muffler since **burn injury** will result.

Vibration behavior is influenced by the condition of the AV elements – check the AV elements at regular intervals.

Using the Unit

HS 81 R

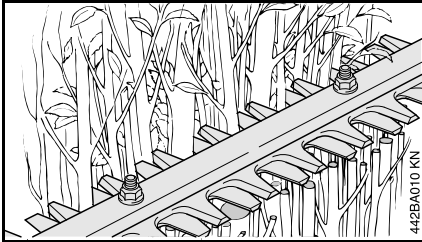

The HS 81 R is designed for cutting hedges and shrubs with thicker stems and branches.

HS 81 T

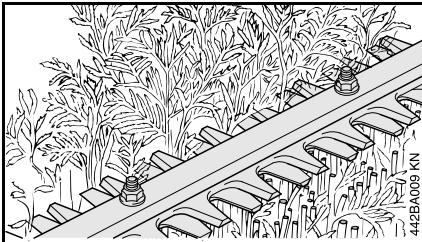

The HS 81 T is designed for shaping and trimming hedges and shrubs with thinner branches.

Use the HS 81 R hedge trimmer for cutting hedges with thicker branches.

Cutting Season

Observe country-specific or municipal rules and regulations for cutting hedges.

Do not use your power tool during other people's rest periods.

Cutting Sequence

Use lopping shears or a chain saw to cut out thick branches first.

Cut both sides of the hedge first, then the top.

Disposal

Do not throw cuttings into the garbage can – they can be composted!

Cutting Techniques

Vertical cut

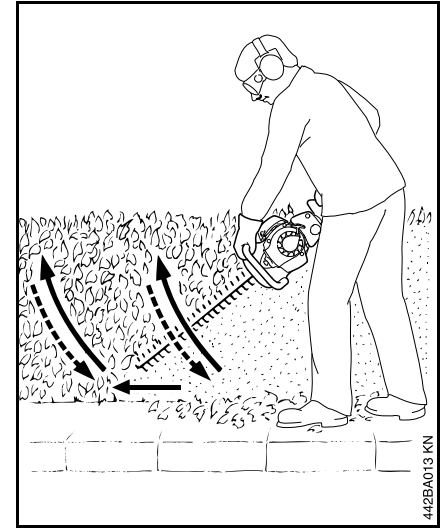

Swing the cutting blade from the bottom upwards in an arc – lower the nose of the blade, move along the hedge and then swing the blade up again in an arc.

Horizontal cut

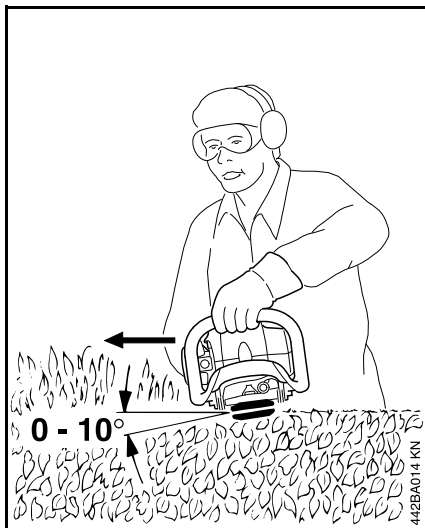

Hold the cutter bar at an angle of 0° to 10° as you swing the hedge trimmer horizontally.

Swing the cutting blade in an arc towards the outside of the hedge so that the cuttings are swept to the ground.

Maintenance and Care

The following intervals apply to normal operating conditions only. If your daily working time is longer or operating conditions are difficult (very dusty work area, etc.), shorten the specified intervals accordingly.		before starting work	after finishing work or daily	after each refueling stop	weekly	monthly	every 12 months	if problem	if damaged	if required
Complete machine	Visual inspection (condition, leaks)	X		X						
	Clean		X							
Control handle	Check operation	X		X						
Air filter (felt)	Clean							X		X
	Replace								X	
Air filter (paper)	Clean							X		X
	Replace					X			X	
Pickup body in fuel tank	Have checked by dealer ¹⁾							X		
	Have replaced by dealer ¹⁾					X			X	X
Fuel tank	Clean							X		X
Carburetor	Check idle adjustment	X		X						
	Readjust idle									X
Spark plug	Readjust electrode gap							X		
	Replace after every 100 operating hours									
Cooling inlets	Visual Inspection		X							
	Clean									X
Spark arresting screen ²⁾ in muffler	Check after every 20 hours of operation									
	Have checked by dealer ¹⁾								X	
	Have cleaned or replaced by servicing dealer ¹⁾									X
All accessible screws and nuts (not adjusting screws)	Retighten									X
Antivibration elements	Visual Inspection	X								
	Have replaced by dealer ¹⁾							X	X	

The following intervals apply to normal operating conditions only. If your daily working time is longer or operating conditions are difficult (very dusty work area, etc.), shorten the specified intervals accordingly.		before starting work	after finishing work or daily	after each refueling stop	weekly	monthly	every 12 months	if problem	if damaged	if required
Cutting blades	Clean		X							
	Sharpen									X
	Adjust blade clearance ³⁾									X
Gearbox lubrication	Check and replenish after every 25 hours of operation									
Safety labels	Replace								X	

¹⁾ STIHL recommends a STIHL servicing dealer.

²⁾ not in all versions, market-specific

³⁾ not in all versions, market-specific or available as special accessory

Main Parts

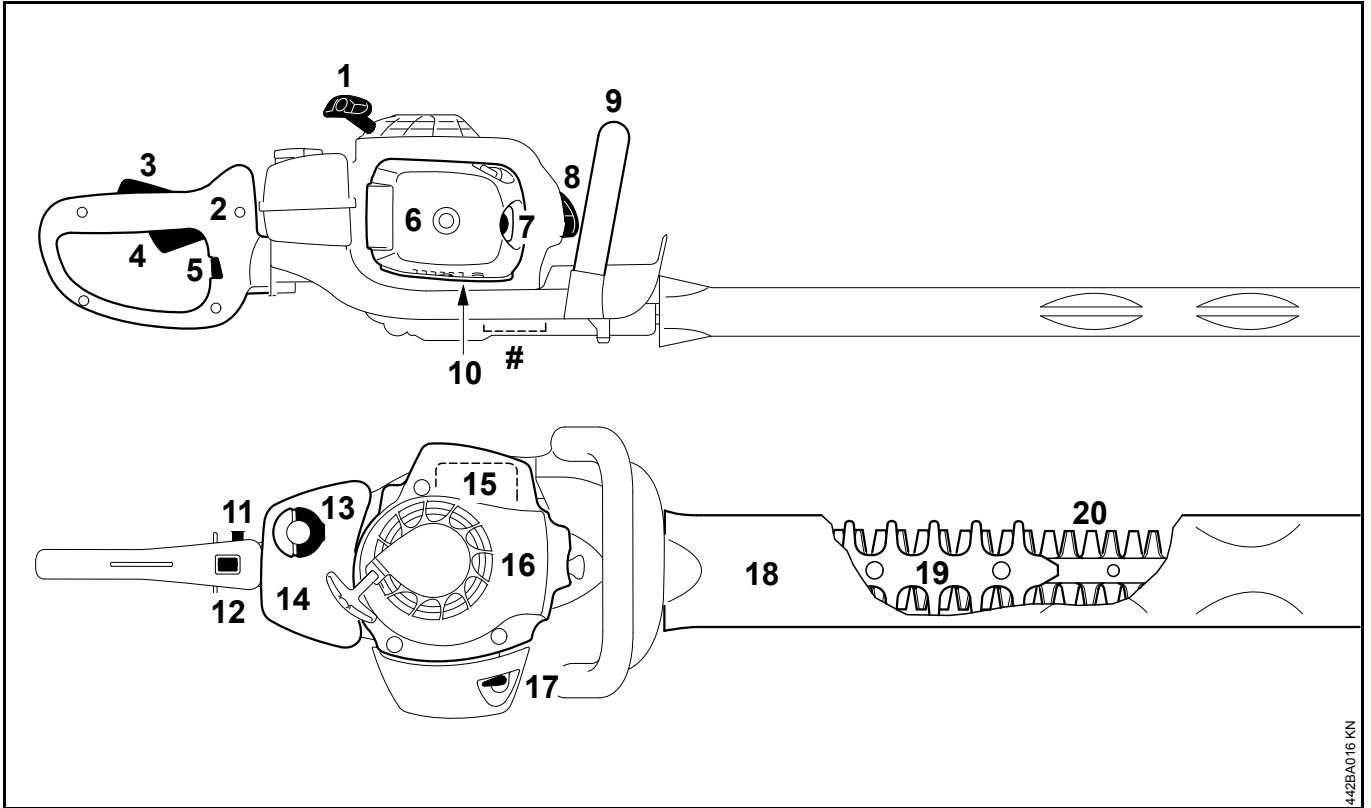

442BA016 KN

English

- 1 Starter grip
- 2 Rear handle
- 3 Interlock lever
- 4 Throttle trigger
- 5 Twist lock
- 6 Filter cover
- 7 Manual fuel pump
- 8 Spark plug boot
- 9 Front handle
- 10 Carburetor adjusting screws
- 11 Starting throttle button
- 12 Stop switch
- 13 Fuel filler cap
- 14 Fuel tank
- 15 Muffler
- 16 Fan housing
- 17 Choke lever
- 18 Blade scabbard
- 19 Cutting blade guard
- 20 Cutting blades
- # Serial number

0457-189-0121

englisch



www.stihl.com



0457-189-0121