



# BCS Rotavator Attachment

Manufactured by BCS S.p.A.

to fit

## BCS Power Units



### Operating Instructions

Before commissioning the machine, read operating instructions and observe warning and safety instructions.

**PLEASE ALSO READ ORIGINAL  
BCS INSTRUCTION MANUAL**



 **TRACMASTER**  
*The landscape machinery specialists*

# Contents

<b>Page 4</b>	<b>Assembly Instructions</b>
<b>Page 5</b>	<b>Identification</b>
<b>Page 6</b>	<b>Safety Precautions</b>
<b>Page 7</b>	<b>Operation</b>
<b>Page 8</b>	<b>Operating Hints</b>
<b>Page 9</b>	<b>Adjusting Rotavator Width</b>
<b>Page 10</b>	<b>Maintenance Guide</b>
<b>Page 11</b>	<b>Replacing the Tines</b>
<b>Page 12</b>	<b>Rotavator Sticker Positions</b>
<b>Page 13</b>	<b>Troubleshooting Guide</b>
<b>Page 14</b>	<b>Risk Assessment</b>
<b>Page 15</b>	<b>Vibration &amp; Sound Levels</b>
<b>Page 16</b>	<b>Machine Overview Diagram (710 &amp; 728)</b>
<b>Page 17</b>	<b>Machine Overview Diagram (738 &amp; 740)</b>
<b>Page 18</b>	<b>Machine Overview Diagram (750)</b>
<b>Page 19</b>	<b>Manufacturer Information</b>

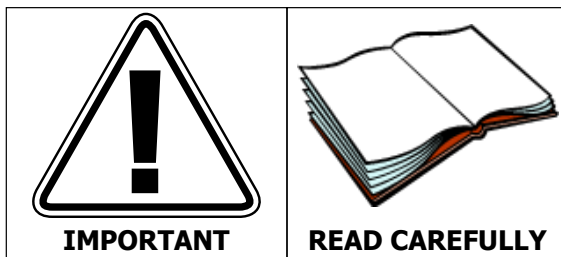

**No liability will be accepted for any damage caused to persons or property through failure to observe the operating and safety instructions.**



# **IMPORTANT**

---

**PLEASE READ THE OWNER'S MANUAL  
FOR THE POWER UNIT FIRST.**

---

**For any further information  
or assistance please contact  
Tracmaster on 01444 247689 or  
visit [www.tracmaster.co.uk](http://www.tracmaster.co.uk)**

## Assembly Instructions

**IMPORTANT:** For all assembly and repairs always wear heavy work gloves to protect your hands (fig. 1).

Remove the rotavator unit from its packing case.

Install the rotavator flap on the rotavator hood using the washers and cotter pins provided (fig. 2).

### Rotavators: 46cm 52cm 66cm 80cm

Attach the rotavator to the power unit by first removing the nuts, washers and PTO cover plate from the power unit and then fitting the rotavator using the previously removed nuts and washers. Make sure the nuts are tightened securely (fig. 3).

Follow the instructions to run the machine (see Power Unit Owner's Manual).

### Rotavator: 85cm

The 85cm rotavator is mounted directly to the machine coupler (fig. 4, A) by attaching the coupler (fig. 5, C) that is fixed to the implement.

The fitting and removal of implements is achieved by rotating the knob (fig. 5, R).

The device is locked by turning the knob clockwise and unlocked by the knob anti-clockwise.

It is important that nuts (fig. 5, D) which fasten the implement and the bushing are well tightened.

Follow the instructions to run the machine (see Power Unit Owner's Manual).

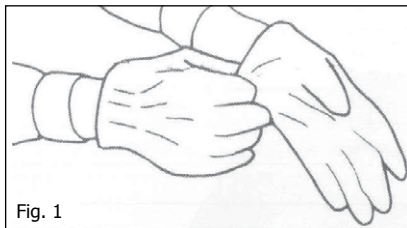

Fig. 1

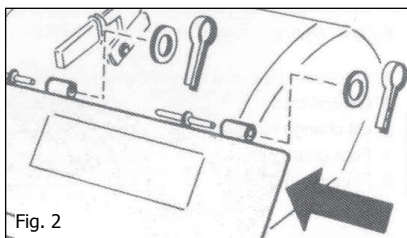

Fig. 2

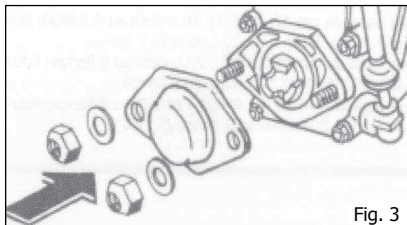

Fig. 3

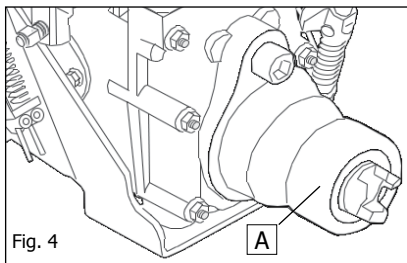

Fig. 4

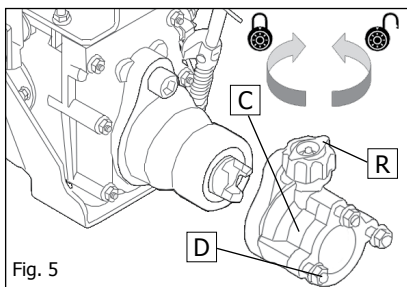
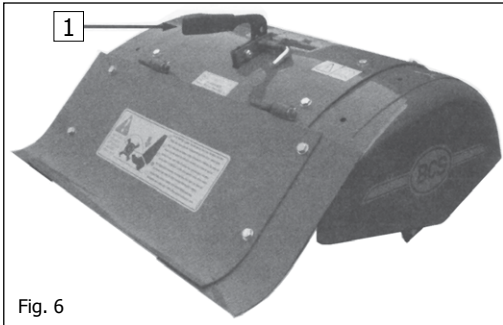

Fig. 5

## Identification



**Rotavators: 46cm 52cm 66cm 80cm**

**Fig. 6**

(1) Adjustment lever for central blade

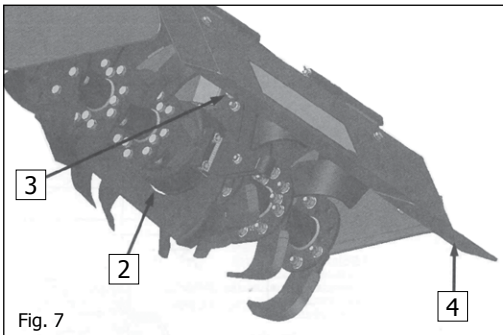

**Rotavators: 46cm 52cm 66cm 80cm**

**Fig. 7**

(2) Central blade

(3) Oil change stopper

(4) Foot guard

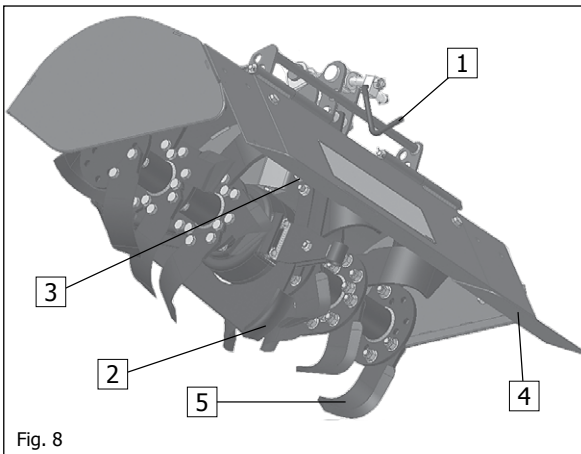

**Rotavator: 85cm**

**Fig. 8**

(1) Adjustment lever for central knife

(2) Central knife

(3) Oil change stopper

(4) Foot guard

(5) Digging knives/tines

Fig. 8

## Safety Precautions

**IMPORTANT:** Read all machine and implement manuals thoroughly before using the rotavator.

Always familiarise yourself with the controls and machine's operation before commencing work. Ensure you know how to stop the machine and turn off the engine safely and quickly.

**WARNING:** Do not put your hands or feet near the work zones or near moving or rotating parts.

Always wear **HEAVY GLOVES** to protect your hands whilst working on the equipment (fig. 1, page 4).

**READ** and observe all warning labels on the machine and implements (fig. 13).

Always wear appropriate work clothes whilst operating the machine, always wear safety footwear.

**DO NOT USE** the machine near children or animals (fig. 14).

The machine operator is responsible for any damage to persons or property.

Always walk with the machine - **DO NOT RUN**.

**NEVER** work on slopes of more than 20° and always work across the face of a slope (side to side), **NEVER** up and down. **NEVER** use the machine on a bank where there is a possibility of the machine sliding down the slope.

Always disengage the power take-off (PTO) when changing direction or location of operation.

**DO NOT** undertake any maintenance of the rotavator while the engine is running.

**ONLY** qualified persons should operate the machine.



Fig. 13

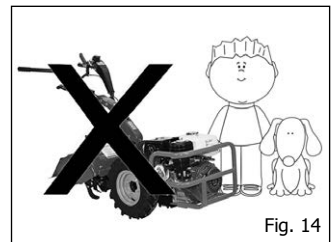

Fig. 14

## Operation



**IMPORTANT: READ POWER UNIT OWNER'S MANUAL FIRST.**

### Before commencing work

Check that the oil is at the required level. See more details on page 10.

Check that the gearstick of the power unit is in the neutral position.

Check that the PTO of the power unit is in the neutral position.

Check that the implement is clean and free of impediments.

### Depth adjustment

Digging depth changes are made through use of the central knife. For shallow digging, set the lever all the way in. To increase digging depth, raise the control lever (fig. 15).

Whilst rotavating, the handlebars can be offset to avoid walking on the cultivated soil, and adjusted in height for the comfort and safety of the operator. See Power Unit Owner's Manual for details on how to adjust the handlebars.

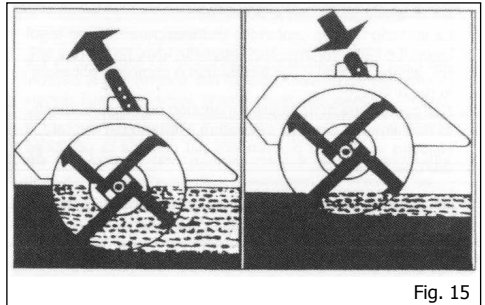

Fig. 15

### To start the power unit

1. Move the red engine ON/OFF lever to position 1 (green).
2. On the engine move the black fuel tap to 'on' position.
3. If the engine is cold move the grey choke lever to 'on' position.
4. Pull the engine recoil firmly to start engine.
5. Return the choke lever to 'off' position.
6. Pull up the clutch lever - **THIS MUST BE DONE BEFORE STEP 7.**
7. Press down the OPC (red stop lever).
8. Select forward speed.
9. Ease the PTO engagement lever forward.
10. Release clutch lever smoothly and completely.

## Operating Hints

**CLEAR THE WORK AREA.** Long grass must be cleared and all debris removed.

**LET THE MACHINE DO THE WORK.** Excessive downward pressure on the handlebars may cause the machine to jump. Apply gentle pressure and the machine will find its own digging depth according to the type of ground.

If the ground is hard, position the depth adjuster centre knife on the top hole and make several passes until the desired depth is achieved.

If the wheel speed or PTO lever does not engage immediately, release clutch lever slightly and 'feel in' with the engine on tick-over. **DO NOT FORCE THE OPERATING LEVERS.**

**BCS 738 and 740 only** - if one wheel begins to lose traction engage the differential lock by pulling the black lever on top of the right hand handlebar towards you to engage drive to both wheels. The clutch is not required to engage the differential lock.

Always pull in the clutch lever before engaging gear, digging unit or changing forward/reverse.

The clutch lever must be fully released when working. Do not operate the machine with the clutch lever partially engaged as serious damage may occur.

If the ground is hard using a lower working speed will produce the best performance. If the soil is loose or sandy a higher working speed is best.

**DO NOT WORK ON SLOPES MORE THAN 20°.** If working on a slope, work across the slope pointing the machine slightly uphill.

**DO NOT ATTEMPT CULTIVATION ON:**

- (i) Frozen or waterlogged ground as this will destroy the soil structure resulting in poor future drainage.
- (ii) Ground that is covered with thick foliage or high grass. Remove it by cutting down.



## Adjusting Rotavator Width

The rotavator width can be adjusted using the following configurations:

Current unit	No of Tines	No of Flanges	Increase or Decrease	New configuration	No of Tines	No of Flanges
52cm (20")	16	4	Increase	66cm (26")	20	6
66cm (26")	20	6	Decrease	52cm (20")	16	4
80cm (32")	24	6	Decrease	66cm (26")	20	6
85cm (34")	20	4	Increase	100cm (40")	24	4

PLEASE NOTE: The 46cm rotavator attachment (12 tines on 4 flanges) cannot be adjusted in size

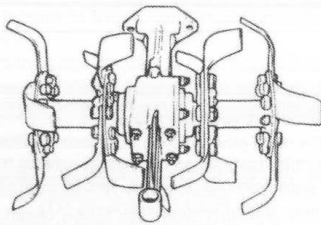

**52cm (20")** - 16 tines on 4 flanges

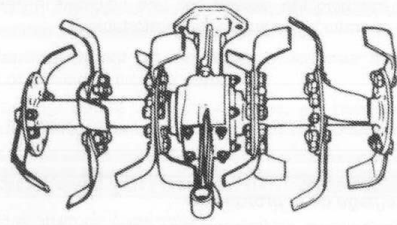

**66cm (26")** - 20 tines on 6 flanges

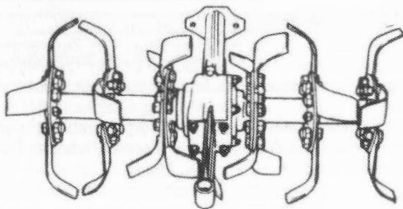

**80cm (32")** - 24 tines on 6 flanges

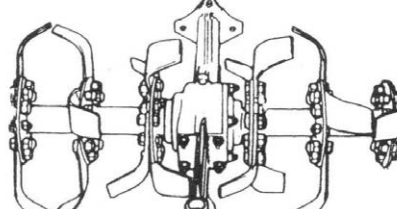

**85cm (34")** - 20 tines on 4 flanges

## Maintenance Guide

For engine maintenance please refer to engine manufacturers manual.

After every hour of operation stop the engine and remove the spark plug cap. Check engine oil level (recommended oil SAE 10w/40). Before checking the oil level ensure the machine is level.

Remove all foreign matter from the digging knives assembly e.g. wire, string, grass etc.

After every 100 hours of use, or once a year (whichever is sooner), check that the oil level in the rotavator transmission is within 50mm (2") of the hole.

To perform this operation, remove the bolts that attach the support rod to the rotavator transmission and the depth handle to the central knife. Raise the rotavator hood, remove the plug and check the oil level (fig. 19), making sure the machine is level. If necessary top up with SAE 80w/90 EP gear oil. Reassemble the unit by performing the operations in reverse.

Remove the gearbox unit dipstick and ensure the oil reaches the top level mark, if necessary top up with API GL-5 80w/90 gear oil (see Power Unit Owner's Manual for more details).

Replace the spark plug cap.

Do not turn the machine on its side for cleaning.

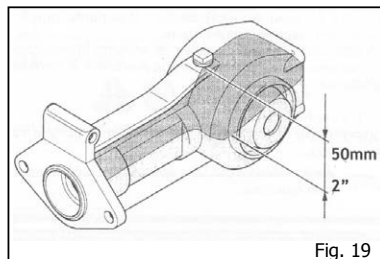

OPERATION	EVERY DAY	EVERY WEEK	EVERY YEAR or 100 HOURS
Check condition of centre knife		X	
Tighten nuts & bolts on tines	X	X	
Check nuts & studs on side flange	X	X	
Check digging unit oil level (EP90)		X	X

**Please note that this maintenance programme relates to the attachment only. For maintenance of the gearbox and controls please see the Power Unit Owner's Manual.**

### **NOTES:**

\* Pressure washing machines removes lubricating grease as well as dirt.

It is imperative all linkages, especially the wheel speed lever detent ball and PTO swivel joint, are kept well greased otherwise they will become difficult to operate and cause damage.

\* DO NOT allow maximum engine speed to exceed 3600rpm.

## Replacing the Tines

To replace the tines, it is necessary to remove the rotavator attachment from the power unit.

Once removed, turn the rotavator upside down (fig. 20) to facilitate replacement of the tines.

LOOK CAREFULLY AT THE ORIENTATION OF THE TINES.

Replace the tines one at a time so that you can use the remaining tines as a reference (fig. 20).

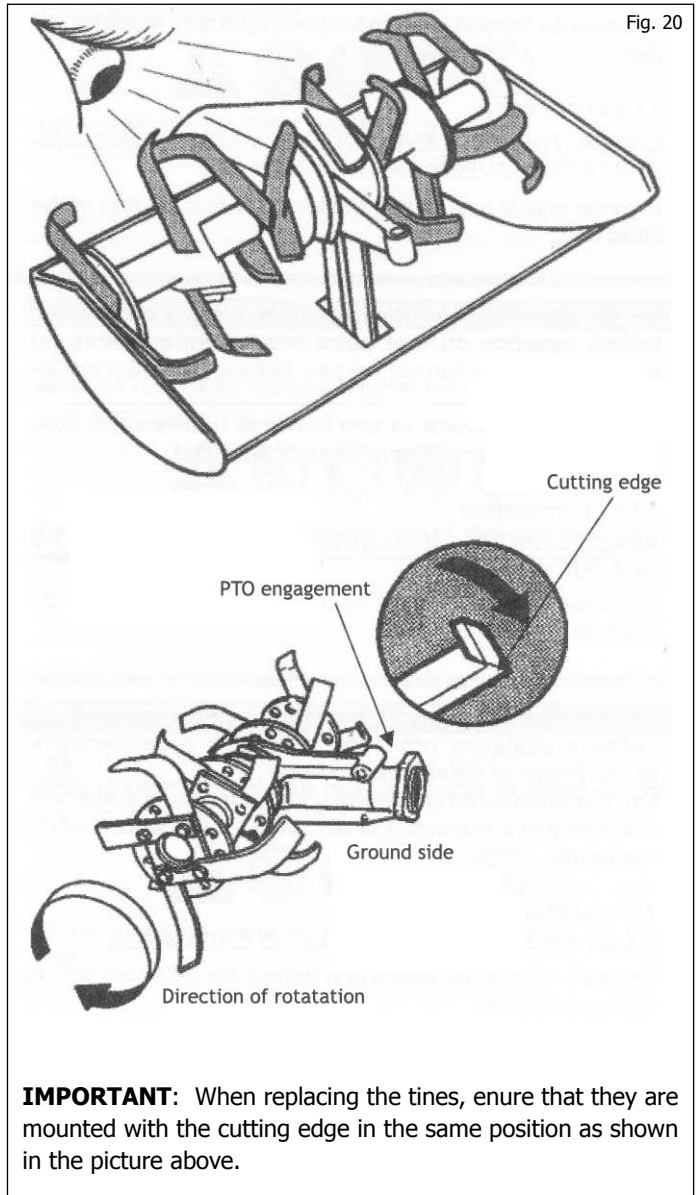

**IMPORTANT:** When replacing the tines, ensure that they are mounted with the cutting edge in the same position as shown in the picture above.

# Rotavator Sticker Positions

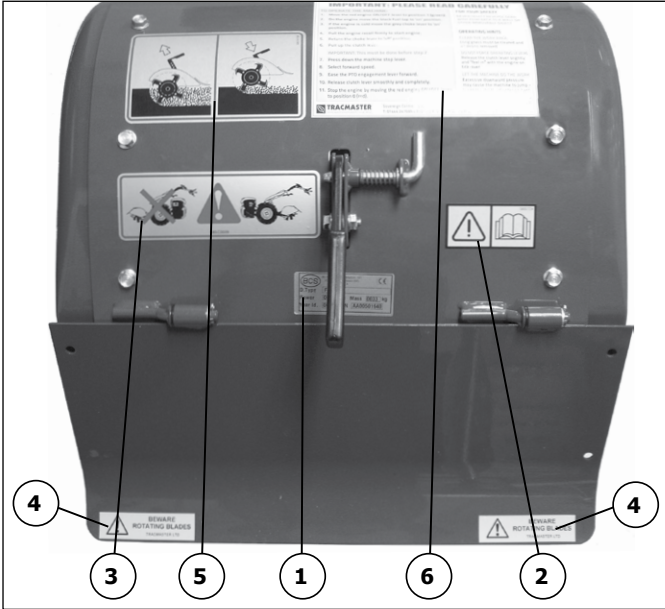

1. CE label  
(part no: 58046963)

2. Read manual  
(part no: 58057724)

3. How to use  
(part no: 580C0039)

4. Beware rotating blades  
(2 off part no: 58046922)

5. Adjustment  
(part no: 580C0054)

6. To operate the machine  
(part no: 810937)

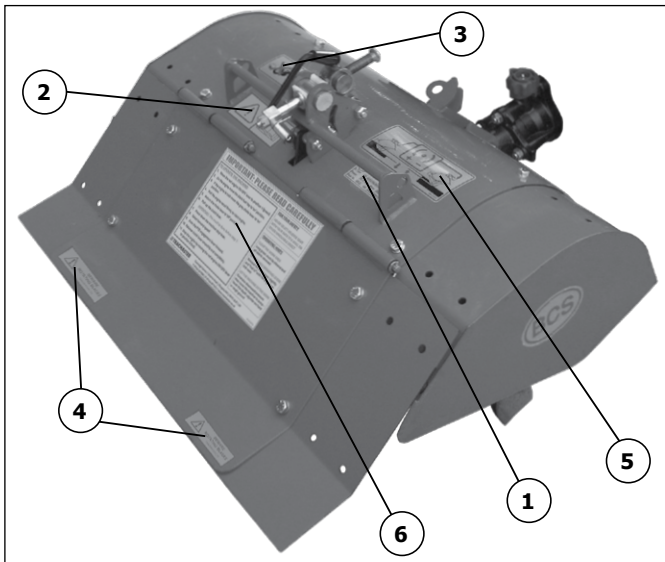

**IMPORTANT:** The labels must be kept clean from dust and mud and must always be clearly visible and legible. They must be replaced if they are missing or illegible. New labels are available from Tracmaster's spare parts department.

## Troubleshooting Guide

PROBLEM	POSSIBLE CAUSE	REMEDY
Machine suddenly leaps forward whilst cultivating.	New set of tines has been fitted the wrong way round.	Check the fitting and refit if necessary.
	Centre knife is worn out or missing.	Check the centre knife and replace if necessary.
	Centre knife lifted too high on hard ground.	Lower centre knife.
No drive to wheels or digging unit.	Check gearbox oil level in the power unit.	Top up if necessary with API GL-5 80w/90 oil (see Power Unit Owner's Manual for more details).

### **NOTES:**

- \* Pressure washing machines removes lubricating grease as well as dirt.

It is imperative all linkages, especially the wheel speed lever detent ball and PTO swivel joint, are kept well greased otherwise they will become difficult to operate and cause damage.

- \* DO NOT allow maximum engine speed to exceed 3600rpm.

## Risk Assessment

HAZARDS	RISK LEVEL	ACTION NEEDED
Machine jumping	High	<p>Ensure the centre knife is in good condition and adjusted to suit the ground conditions. Use the depth adjuster located on top of the rotavator to adjust the centre knife.</p> <p>NEVER apply excessive downwards pressure on the handlebars.</p>
Lacerations	Medium	<p>Remove the spark plug cap before carrying out any maintenance or cleaning. Always wear gloves when cleaning the tines or removing debris.</p>
Flying objects	Low	<p>Ensure the back flap moves easily and follows the contour of the ground to prevent small stones being thrown back. Always wear suitable safety footwear.</p> <p>NEVER use the back flap as a grader.</p>
Foot injuries	Medium	<p>The machine has a safety device to prevent the reverse speed and tine drive being engaged simultaneously. Ensure all safety devices are in place before using the machine. Always wear suitable safety footwear.</p>

## Vibration & Sound Levels

Power Unit	Petrol Engine			Diesel Engine		
	L <sub>Aeq</sub> (1)	L <sub>wA</sub> (2)	m/sec <sup>2</sup> (3)	L <sub>Aeq</sub> (1)	L <sub>wA</sub> (2)	m/sec <sup>2</sup> (3)
710	85.0	101.7	3.13	n/a	n/a	n/a
728	85.9	101.7	3.13	n/a	n/a	n/a
738	85.9	101.7	3.13	89.6	105.2	2.06
740	85.9	101.7	3.13	89.6	105.2	2.06
750	85.9	101.7	5.79	99.1	108.0	18.28

(1) L<sub>Aeq</sub> - ACOUSTIC PRESSURE: values expressed in equivalent dB(A).

(2) L<sub>wA</sub> - ACOUSTIC POWER: values expressed in dB(A).

(3) m/sec<sup>2</sup> - VIBRATION: average square value calculated at handlebars according to UNI EN 709.

# Machine Overview Diagram

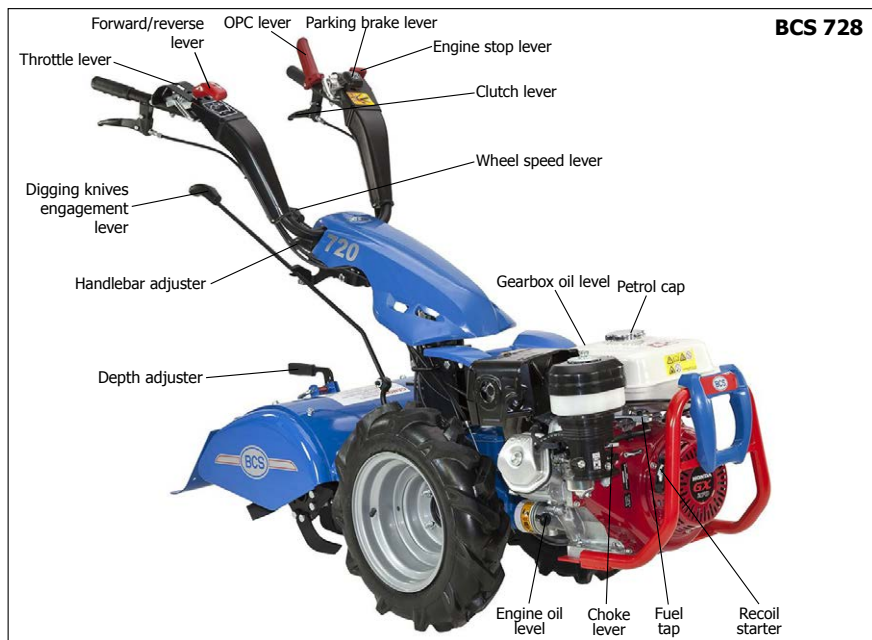
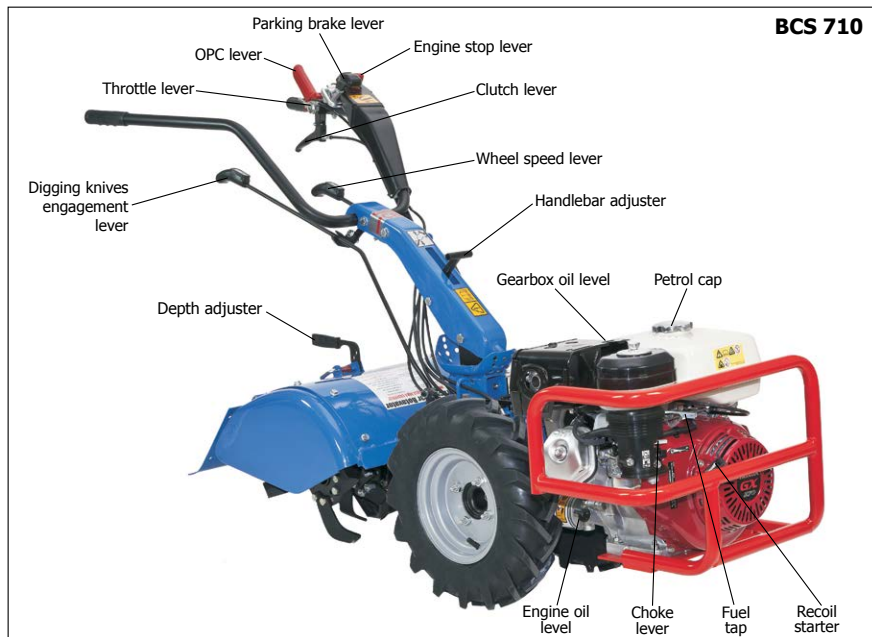



# Machine Overview Diagram

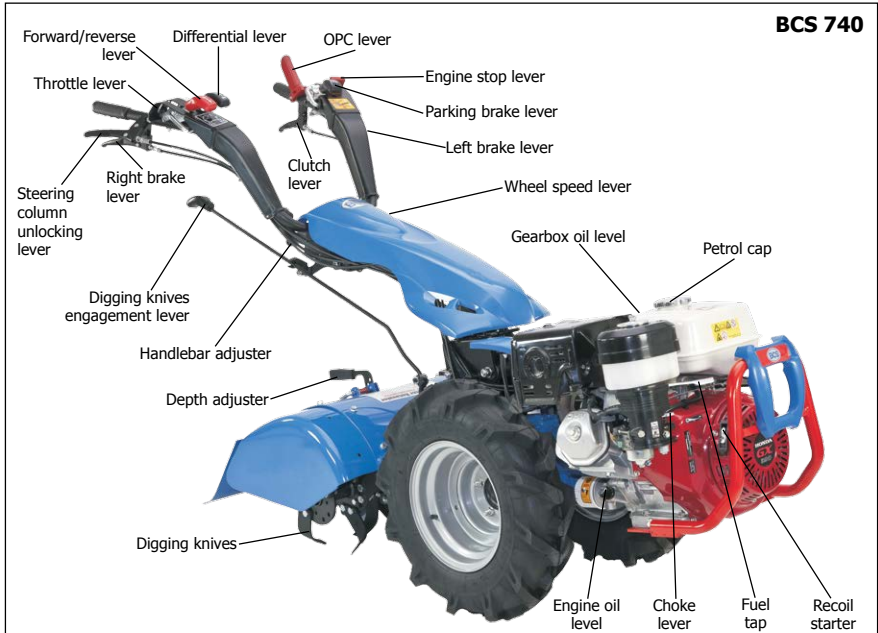
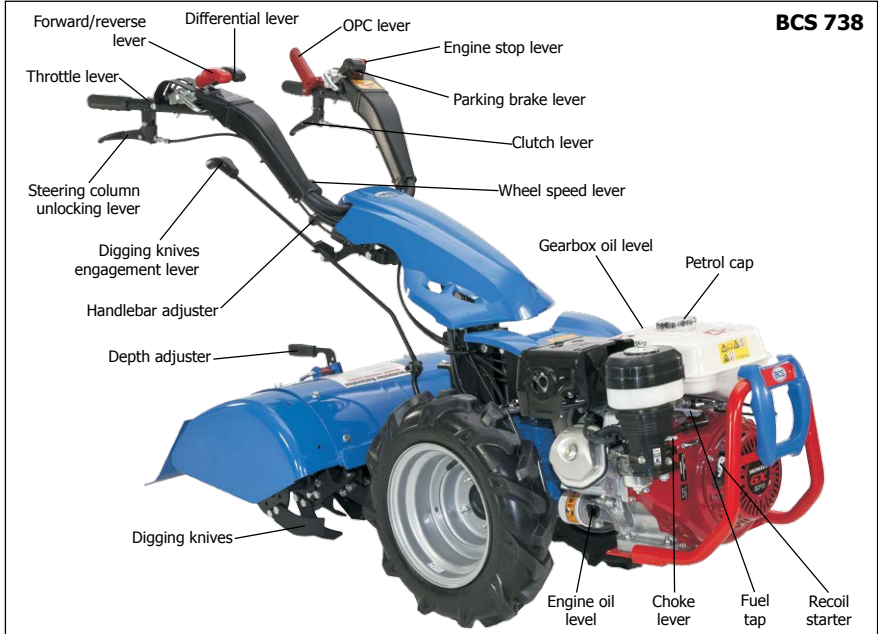

# Machine Overview Diagram

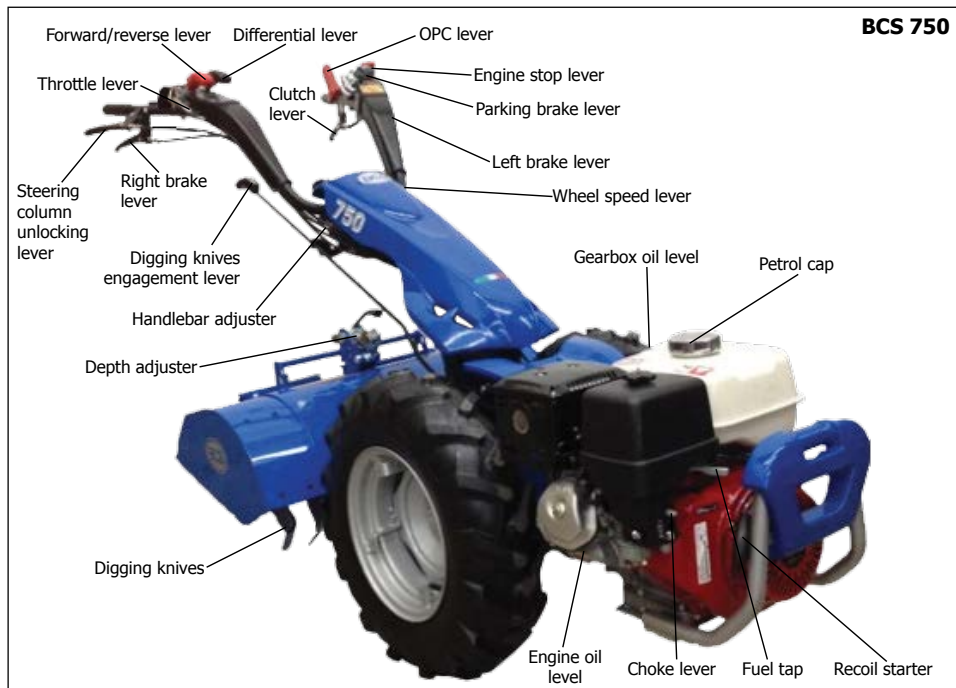

## Manufacturer Information

This machine is manufactured in Italy by BCS S.p.A.

Tracmaster Ltd is the UK distributor for these models, the BCS Rotavators.

BCS S.p.A. has been at the forefront of developing cutting edge agricultural machinery since its formation in 1943, when their founder developed a self-propelled motor mower. Tracmaster Ltd has been the UK distributor for BCS pedestrian equipment since 1984.

Please ensure you read the original manufacturer's manual before operating this machine.



**BCS S.p.A.**

V.le Mazzini, 161  
20081 Abbiategrasso (MI)  
Italy

Tel: +39 02 9482 1

Fax: +39 02 9496 0800

Email: [info@bcs-ferrari.it](mailto:info@bcs-ferrari.it)

Website: [www.bcsagri.it](http://www.bcsagri.it)

© Tracmaster Ltd 2017.  
Specifications are subject to change without prior notice.



Tracmaster Ltd, Sovereign Centre, Victoria Road, Burgess Hill RH15 9LR  
T: +44 (0) 1444 247689 F: +44 (0) 1444 871612  
W: [www.tracmaster.co.uk](http://www.tracmaster.co.uk) E: [info@tracmaster.co.uk](mailto:info@tracmaster.co.uk)